

BeachHunter 300

Table of Contents

Assembly.....	2
Assembly Instructions.....	3
Proper Care	3
Batteries	4
Standard Battery Holder	4
Using the Standard Battery Holder.....	4
Quick Start	5
Quick Start Instructions	5
Controls	6
Threshold	6
Sensitivity	6
Tips on Ground "Balancing"	7
Ground	7
Toggle Switch	8
L.E.D. Display	9
What the lights mean	9
Red.....	9
Yellow	9
Green.....	9
Searching.....	10
Operator Techniques	10
When you get a Beep!.....	10
Responsible Detecting	11
Owner Information.....	12
Service	12
Warranty	13
Warranty Transfer	14
Warranty UK	15
Warranty Transfer UK	16

Assembly

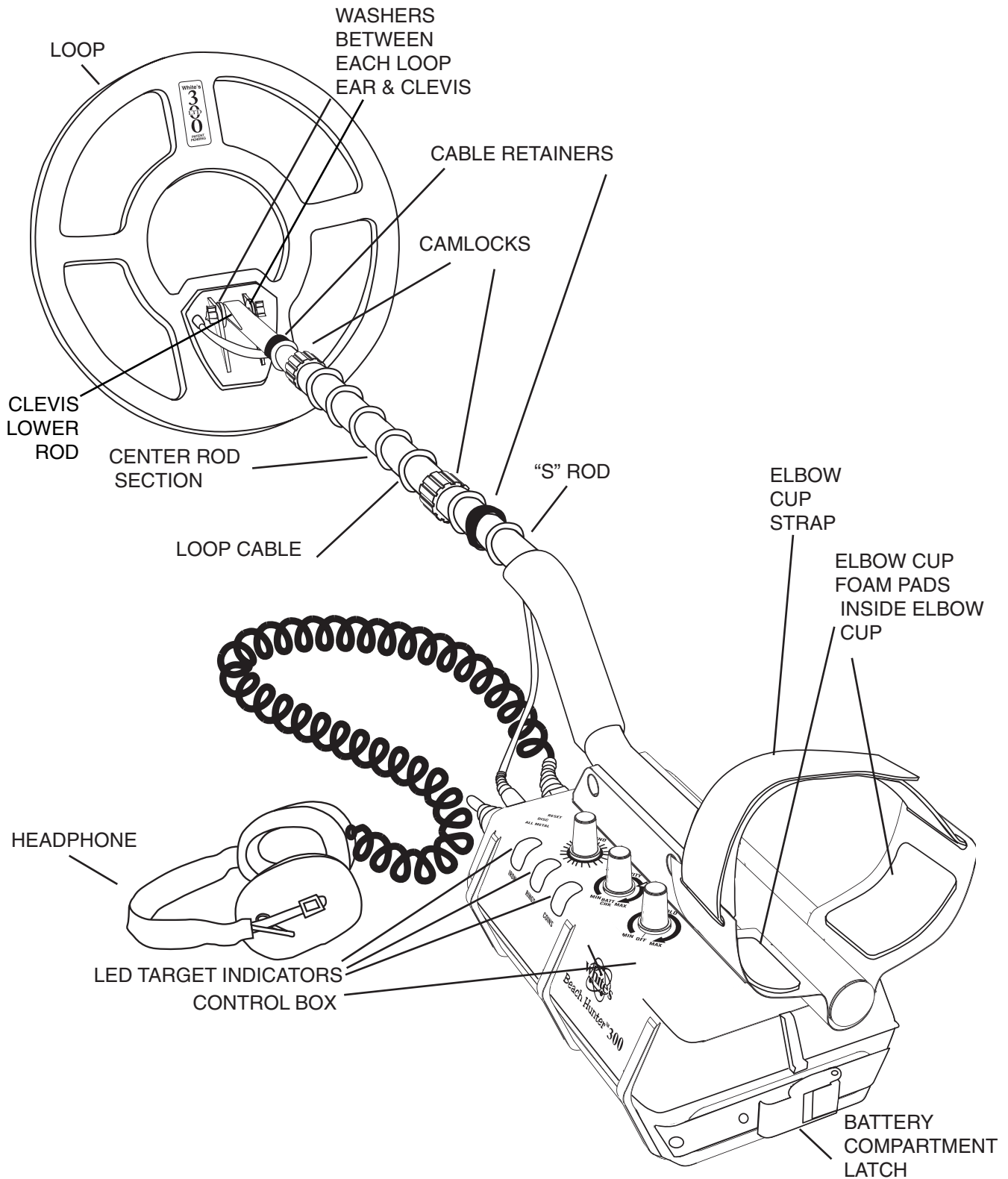

Assembly Instructions

1. Remove all parts from shipping carton and check the assembly page to make sure all parts are present. Remove control box from the “S” rod by compressing both the spring clip buttons on one side of the rod and pivoting the control box off.

For superior water proofing, the Loop, Headphone, and their cables are hard wired (not removable) from the control box, headphone and loop. The waterproof fitting and strain reliefs on the cables are torqued to a specific ideal setting and should not be loosened or tightened. Extra care/effort must be taken in assembly regarding winding the cable around the rod.

2. Unlock “S” rod camlock and insert the reduced end of the center rod into curved “S” rod so that stainless steel spring clip buttons line up and lock into the holes in the curved “S” rod. Turn camlock to secure.

3. Fit the rubber washers between clevis/lower rod and searchcoil ears. Use only non-metallic washers, fiber bolt, and thumbnut, to secure loop to clevis/lower rod. Then insert into center rod so that stainless steel spring buttons line up and lock into one of the adjustment holes in the center rod. Turn Camlock to secure.

4. Unravel cable and wind the cable around the clevis and rod assembly, first revolution should be OVER the top of the rod with some slack before applying the cable retainer. This is done so that the search coil can be paddled backwards toward the rod without putting a strain on the cable. Wind cable firmly all the way to the curve in the “S” rod. Then attach control box to the rod by compressing the two spring clips on the rod aligning and inserting control box lid bracket. To secure cable, wrap velcro cable retainers around rod and cable, one near the search-coil and one near the padded handle on the “S” rod.

5. Grip the instrument by the handle, with your arm in the elbow cup with strap secure, and sweep the coil over the floor. If the instrument fit feels uncomfortable, adjust the elbow cup by removing and repositioning the bolt/thumbnut and installing in one of the optional positions. If necessary, readjust clevis/lower rod length with the spring clip buttons so that the searchcoil can be held near

the floor without requiring stooping over.

6. Adjust the elbow cup strap so that it is loose enough for you to slide your arm in and out without loosening each time you want to set the detector down. Peel and stick elbow cup foam pads on the inside of the elbow cup, one on each side.

7. Install batteries as described in the next section.

8. This model can be mounted on two different positions on the rod, forward or aft. Or the control box may be left off the rod for hip mounting using the provided pouch and any belt (two inch preferable).

9. It should be noted at this point that the detector may not work as expected indoors due to the high degree of metals (nails, pipes, etc.) used in modern construction and the presence of electrical interference. It is best to tune and practice out-of-doors to ensure stable, predictable results.

Proper Care

1. **Cleaning** - The BeachHunter 300 is waterproof and can be cleaned with water & mild soap.

2. **Battery Door** - Keep the rubber battery door clean and free of sand. Do not lubricate.

3. **Weather** - Do not expose your detector to the conditions of a car trunk during winter and/or summer extremes. Protect your detector from direct sunlight during storage.

4. **Water** - Saltwater is very corrosive! After your detector has been exposed to salt, rinse it with fresh water. Wipe down the control box with a damp cotton cloth. Do not allow water inside the battery compartment or control box.

5. **Storage** - When not in use, make sure the THRESHOLD knob is turned fully counterclockwise, to the OFF. If you plan on storing your detector for long (several weeks), remove the battery holder from the instrument and remove the battery cells from the holder. Store the instrument indoors, in an area where it will be protected from abuse.

6. **Additional Precautions** - Avoid dropping your detector while attempting to set it down to dig. Avoid using your detector for leverage when standing up from a dig. Do not modify your instrument during its warranty period.

Batteries

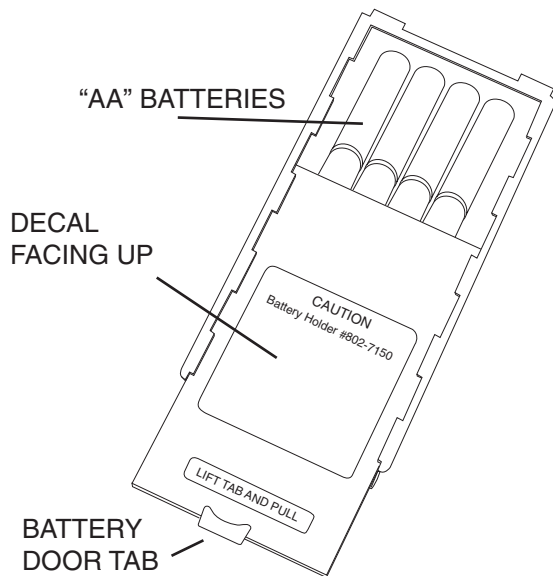

Standard Battery Holder

1. The standard battery holder holds eight "AA" cell batteries. Alkalines are recommended for use with this model. During normal searching conditions you can expect about 40 hours of hunting time from one set of eight alkalines.

2. Non-alkalines can be used in this holder. When non-alkalines or rechargeable "AA" cells are used, detecting time (before replacement/recharge) will be reduced to about 30 hours.

3. Once the batteries become weak, the blue/green light fails to light when the SENSITIVITY control is turned to BATT CHK. The beep over metal targets will be reduced in volume when low batteries are used. Shortly thereafter, the instrument will no longer respond to metals.

4. The battery compartment opens by disengaging the latch, disengaging the two hooks on each side and removing the large rubber door. Tilt the instrument to slide the battery pack from the control box.

Using the Standard Battery Holder

1. Slide open the battery holder lid (decalside of battery holder) by applying gentle upward pressure on the tab of the door so that it unlocks. Slide the door away from the battery box exposing the cell positions.

2. Remove any old cells from the holder. **Note the (+) and (-) positions of each cell and the (+) and (-) for each position marked inside the cell tray. Install new "AA" cells noting carefully the correct (+) and (-) positions.**

If the cells are installed incorrectly, the detector may require service by an Authorized Service Center.

3. Slide the door closed so that it snaps securely.

4. Insert the battery holder into the detector so that the **decals facing up**, with the battery holder door tab and metal contact points facing toward the inside of the battery compartment.

Make sure the large rubber battery compartment door is dry and free of sand/debris, insert it into place (only fits one way). Secure the two hooks on each side of the case. Then engage the latch.

An optional rechargeable system incorporating the latest in state of the art non-memory characteristics is available for the BeachHunter 300 White's nicad #802-5211, and charger #509-0022 are recommended.

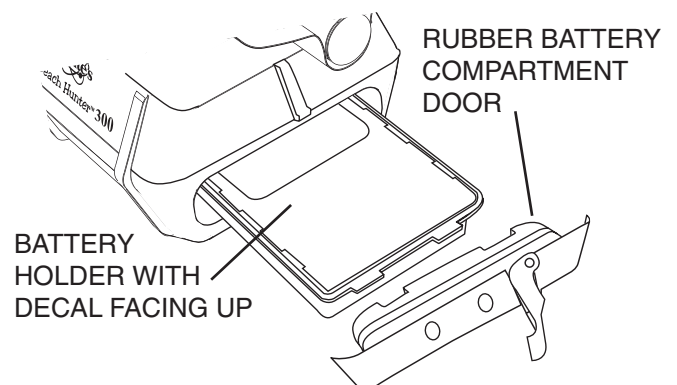

Quick Start

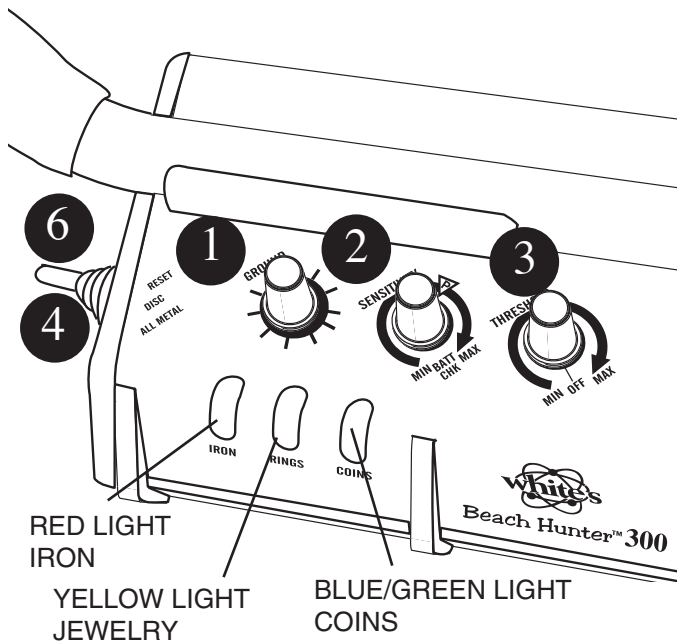

5

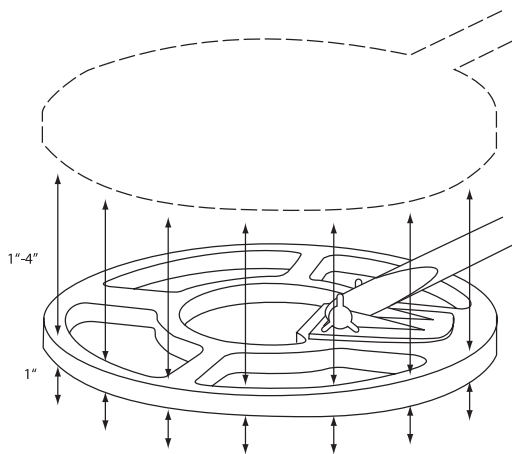

7

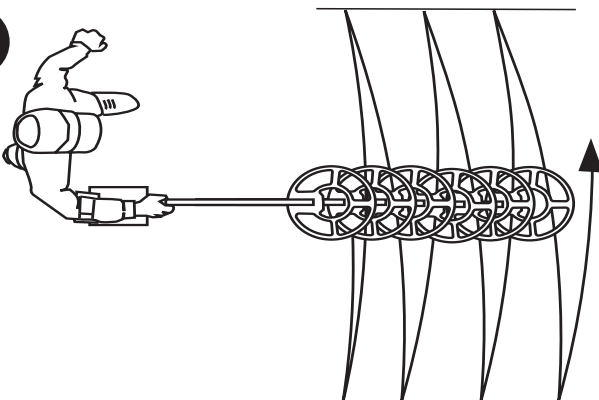

Quick Start Instructions

- 1 Once fully assembled, and the batteries installed, rotate the ON/OFF THRESHOLD knob until a slight hum is heard.
- 2 Turn the SENSITIVITY knob to BATT CHK position and assure blue/green light is visible, then set the SENSITIVITY knob to "P" (Preset).
- 3 Set the GROUND control to center (1/2 rotation from either end stop).
- 4 Set the toggle to the left, ALL METAL position.
- 5 Lower the search coil (loop) to search height (approx 1" above the ground.) Pump the search coil slowly up and down (from 1" to 4") and notice the change in volume of the background hum.

If the hum INCREASES on the downstroke, turn the Ground control knob to the LEFT. If the hum DECREASES on the downstroke, turn the Ground control knob to the RIGHT. When you hear no change in the hum when pumping the searchcoil, the BeachHunter 300 is "GROUND BALANCED" for the area you are searching.

- 6 Set the toggle to center, DISC position.
- 7 Start making wide overlapping sweeps 1" above the ground. Listen for the low (iron/trash), medium (gold jewelry, nickel, aluminum) and high (silver and copper coin) beeps and watch the corresponding L.E.D. lights tell you what treasure lies beneath your feet!

Controls

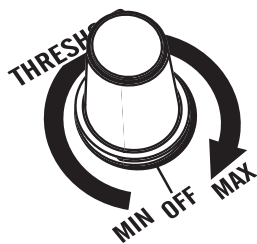

Threshold

The THRESHOLD knob turns the instrument ON/OFF and adjusts the steady background hum or “threshold” that should be heard continually during use. The ideal setting is the softest you can hear.

If threshold is not desired, turn the THRESHOLD control just slightly counterclockwise to silence. Although some performance may be compromised, respectable results can still be achieved.

Turn the Threshold fully counterclockwise OFF when not using the BeachHunter 300 (For prolonged periods of storage of two weeks or more, remove the battery holder from the instrument.)

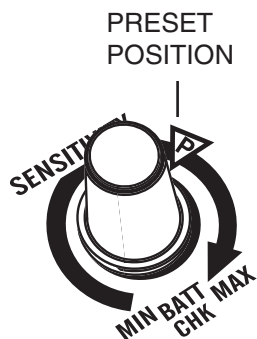

Sensitivity

The SENSITIVITY control adjusts the responsiveness to metal targets as well as the amount of interference from external electrical sources and ground peculiarities. It also functions as a battery check by turning the knob fully counterclockwise to activate the blue/green LED “coins” indicator light.

In most conditions the “P” (Preset) position is ideal. If interference becomes apparent (false signals or instability), reduce the SENSITIVITY control (counterclockwise) until smooth, stable operation is restored.

If smooth, stable operation is noted at “P” (Preset), increasing the SENSITIVITY control (clockwise) may increase detection depth so long as stable predictable results can be achieved.

The SENSITIVITY control will also dictate the sensitivity of the I.D. display. If set too high for the conditions the display may become unreliable. We advise reducing the sensitivity control by turning it slightly counterclockwise to restore accuracy.



Ground

The Ground control adjusts the level of rejection against ground mineralization. When set properly the detector will ignore most common ground including salt. Fine tuning the GROUND control for the area will improve performance particularly when the All Metal mode is used.

To fine tune the GROUND control first go to the area you wish to search.

Place the loop on the ground (search height).

Turn the THRESHOLD control clockwise until a slight hum (threshold of sound) can be heard.

Place the TOGGLE in the All Metal position.

Pump (lift and lower) the loop from the ground raising about four inches and lowering to search height while listen to the threshold. The threshold will either stay the same (desired), increase in volume, or decrease in volume.

Pay attention to the change in sound **only** as the loop approaches the ground.

If the threshold sound decreases as the loop approaches the ground, start turning the GROUND control “clockwise” or “up” slowly while continuing to pump the loop over the ground.

If the threshold hum increases in volume as the loop approaches the ground, start slowly turning the GROUND control “counterclockwise” or “down” while continuing to pump the loop over the ground.

Once completed, switch the toggle switch to the DISC setting if trash rejection is desired

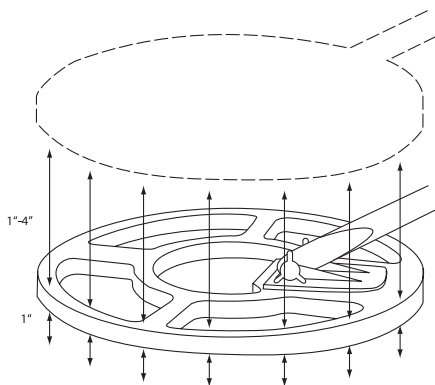
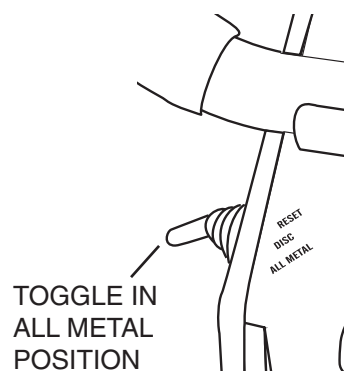

Tips on Ground “Balancing”

Think of the GROUND control as a volume level for the ground. With the loop approaching the ground, if the “hum” gets louder, turn the control down. If it gets softer, turn the control up. The goal is to find the ground setting that allows little or no change in threshold “hum” as the loop is lowered and lifted from search level. If a steady “hum” is difficult to accomplish, slightly reduce the SENSITIVITY control (turn counterclockwise) and try again.

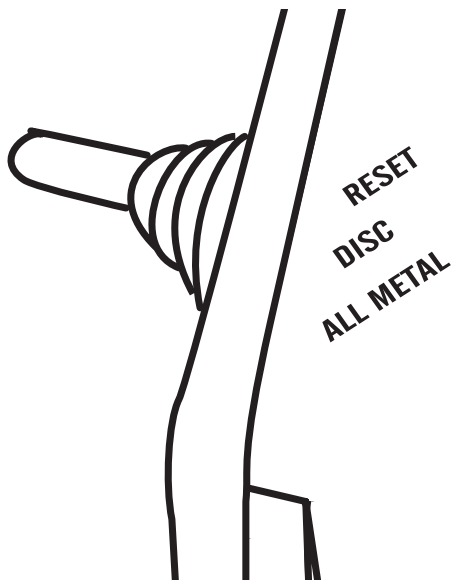

Toggle Switch

The TOGGLE selects between the two operating modes **DISC** and **ALL METAL**.

DISC

is the most common operating mode and will provide one of three distinctive tones depending upon the metal type.

Low tone (broken or inconsistent) indicates iron or steel.

Medium tone indicates jewelry/nickel. Lead and medium size aluminum also indicate in this medium tone category. An operator must dig lead and medium aluminum in order to successfully recover jewelry.

High tone indicates copper/silver coin range. Large aluminum (pop cans) may also indicate in this high tone range.

ALL METAL

This position responds to all types of metals with the same tone “beep”.

All Metal may detect deeper in some areas when compared to the DISC mode.

Pinpointing is best completed in the All Metal mode. Although some slight motion of the loop is required for continued detection, the degree of motion is very minimal.

The LED display will still indicate target category regardless of the TOGGLE position.

Setting of the GROUND control is recommended in the All Metal mode.

RESET

This position resets or clears the LED display lights and while being held in RESET switches from DISC to All Metal.

It is not necessary to reset the LED display during normal searching. Each new target will automatically reset the LED and provide a new indication.

An operator may want to reset the LED display and sweep a particular target a second time during testing or experimentation.

Primarily, the RESET is used to momentarily access the All Metal mode for quick pinpointing. Once released, the TOGGLE will automatically return to the DISC position.

L.E.D. Display

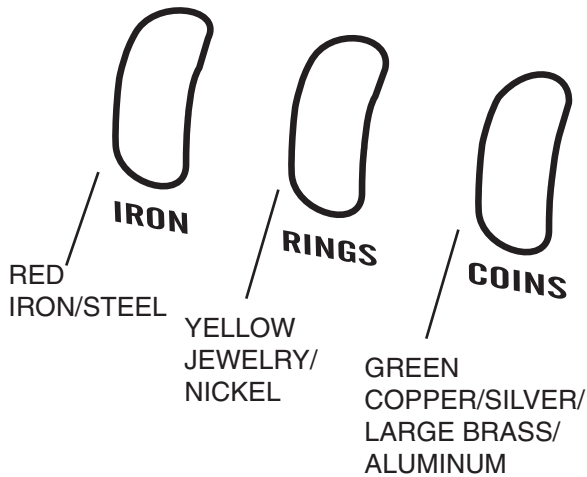

What the lights mean

The high intensity L.E.D. display indicates the possible category or type of metal currently being detected.

It is normal for the display to show and hold a random indication during use, as well as indicating targets while searching in the All Metal mode. The L.E.D. display will reset with the TOGGLE pushed to the Reset position and released but it is not necessary. The L.E.D. display automatically produces a new indication each time a new target passes near the loop. Consult the display indication only when it is accompanied by a smooth repeatable audio sound.

During heavy interference, if the SENSITIVITY control is set too high for the conditions, display accuracy may be reduced. If errors are excessive, reduce the SENSITIVITY control by turning it slightly counter clockwise.

Red

This L.E.D. indicates the metal is likely iron or steel such as nails, steel bottle caps or iron relics. Dig only if iron/steel is of interest.

Yellow

This L.E.D. indicates the mid range where jewelry and nickel most often falls. Unfortunately aluminum and lead also fall into this category. To successfully find jewelry one must dig nickels, small to medium aluminum and lead.

Green

This L.E.D. indicates the high end of the scale where copper and silver coins typically indicate. Large brass, large aluminum, and other large non-ferrous (not of iron) metals may also indicate in this area.

Searching

Operator Techniques

To get experience with the sound of metal objects in the ground, place a large nail, and/or a steel bottle cap (not aluminum), a silver coin, and an item of jewelry (mans gold ring preferred) on the ground. Sweep the loop over these metals at a rate of three to four seconds per pass. Note on the iron/steel the inconsistency in the beep, and that it is a lower tone and/or has a flutter to the sound. Note that typically jewelry produces a medium tone beep and that it provides a more consistent smooth sounding beep. Note that the coin produces an even higher tone beep and is also more consistent. An operator will soon learn to ignore the lower tone flutter sounds trash produces and listen for the smooth consistent medium and higher tone beep that coins and other valuable metals produce.

Once a smooth consistent medium to high tone beep has been located, sweep the loop directly over the center of the target several times and read the possible I.D. on the L.E.D. display. Like the audio discriminator, the display will tend to fluctuate on trash, and read more consistent on valuable metals. This is why we recommend relying on the audio beep as the primary indication, and then check the Display I.D.

The display will produce and hold indications as the loop passes over ground, trash, and other metals. Ignore the display until a consistent medium to high tone beep has been located.

The more consistent the display, the more likely the indication is correct. Trash metals tend to indicate inconsistently.

Caution: two different types of metals lying near each other in the ground may produce multiple display indications that may appear to mimic trash. Use the pinpoint “x” ing method to isolate the targets.

When you get a Beep!

Pinpoint exactly where to dig by placing the TOGGLE in the All Metal position and “X-ing” the loop slowly over the area “eyeballing” the center. The detector will “beep” as the physical center as the loop passes the center of the target.

As the loop nears the center of the target the sound will increase in both tone and volume. The loudest and highest tone beep indicates target center (V.C.O.-Voltage Controlled Oscillator).

Note that some very slight loop movement is required. It is a good idea to place coins on the ground and practice pinpointing. It takes some time to develop pinpointing skills. Return the TOGGLE to the DISC position prior to general searching.

For fast pinpointing the TOGGLE’s Reset position can be used. When pressed and held in Reset, the All Metal mode is temporarily accessed for pinpointing. Once released the TOGGLE will automatically return to DISC for searching.

If the desire is to detect iron/steel such as tools, relics or property stakes, place the TOGGLE in All Metal and leave it there during searching. Common metals will respond with the same tone beep.

The L.E.D. display will continue to indicate I.D. regardless of the toggle position.

Proper setting of the GROUND control is more critical when searching in All Metal.

If searching near other metal detectors, rarely cross talk or interference will result. However, if you note some static chatter, simply increase the distance between you and the other metal detector.

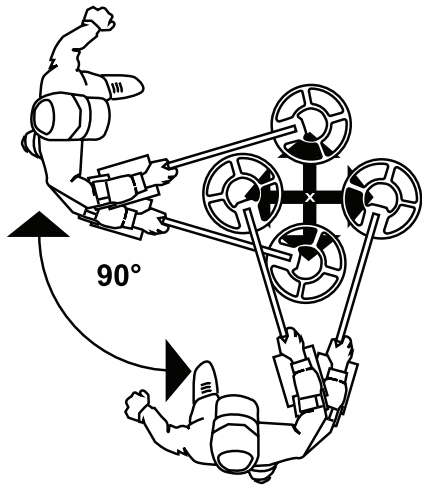

PINPOINTING BY "X"ING THE LOOP

Note: For searching in extreme conditions, improved performance (increased depth) may result by reducing the SENSITIVITY setting.

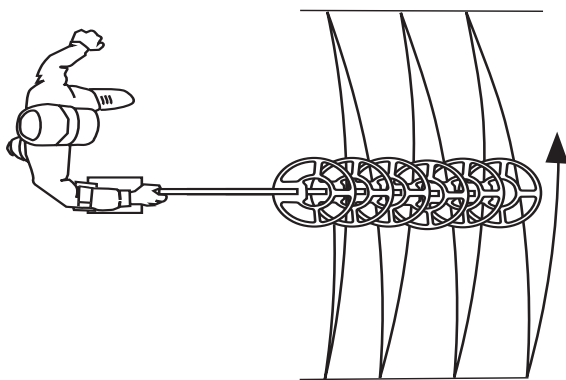

Because the loop must be moving in order to accurately respond, the sweep of the loop is critical to performance. Sweep the loop close to the ground. Keep it close throughout the sweep. Overlap each pass by at least 50%.

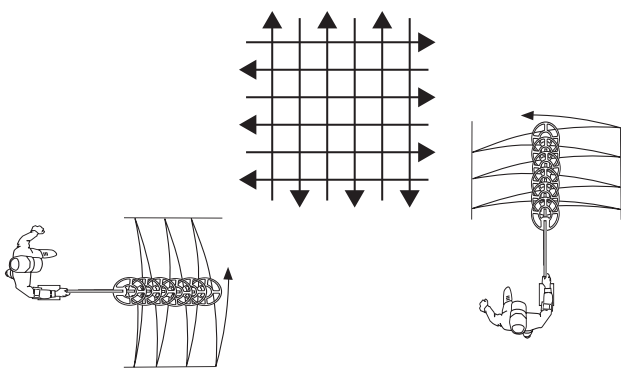

Productive areas or areas that have potential, should be searched from at least two different directions, at ninety degree angles from each other.

Responsible Detecting

Care must be taken to use the appropriate digging tool for the terrain, and not to leave unsightly excavations or holes on other peoples property.

There are hundreds of digging tools designed to minimize the impact removal of small items has on the grass and vegetation. Tools can also avoid damaging the items found.

Sand scoops are all that is needed in some areas, in others a hand gardening spade. Challenging ground conditions may require more sophisticated tools. Check with your Dealer regarding an appropriate tool for your area.

The beach replenishes itself with each season and with each shift in the sand. The more traffic (people) and the longer (older) the traffic, the better the odds of lost valuables.

You may want to start with your own yard. Valuables can be found anywhere people have congregated, gathered, lived, sat, walked, played, camped, picnicked, traveled or fought.

Any area inhabited before 1965, is likely to have the older styles of collectable coins.

You must have permission to search both private and public property from the owner or person in charge of managing the property. In most cases, you can locate the owner, or available permit system, through City Hall or the County Seat.

If the area is City owned contact the Parks and Recreations Department. If it is a State or Federal Park contact the superintendent or grounds keeper. Known and marked historical sites, parks, and monuments, typically are off limits to metal detecting.

Information

Service

White's reputation has been built on quality products backed by quality service. Our Factory Authorized Service Centers are factory trained and equipped. They offer the same quality service as the factory. Service before and after the sale is the cornerstone of our customer relations.

White's Authorized USA Service Centers:

Centerville Electronics
10063 Wellington Rd.
Manassas, Virginia 20110
Toll Free 1-888-645-0202
Fax: 1-703-222-8625
E-Mail: centelec@vwx.com

Electronic Exploration
575 West Harrison
Lombard, Illinois 60148
Toll Free: 1-800-392-3223
Fax: 1-630-620-1005
E-Mail: tony@ee-il.com

White's Electronics, Inc.
1011 Pleasant Valley Road
Sweet Home, Oregon 97386
Telephone: 1-541-367-6121
Fax: 1-541-367-6629
E-Mail: nbaker@whiteselectronics.com

Before shipping detectors for service:

- A.** Contact your Dealer. There may be a quick, simple fix or explanation that will prevent having to send the detector in for service.
- B.** Double check the obvious, such as batteries, and try the detector in another area to be sure there is not interference.
- C.** Be sure to send all necessary parts with your detector, such as search-coil, batteries and holders, as these items can result in symptoms.
- D.** Always include a letter of explanation about your concerns, even if you have talked to the Service Center by telephone.
- E.** Take care in packaging instruments for shipping and always insure your package.

Warranty

If within two years (24 months) from the original date of purchase, your White's detector fails due to defects in either material or workmanship, White's will repair or replace at its option, all necessary parts without charge for parts or labor.

Simply return the complete detector to the Dealer where you purchased it, or to your nearest Authorized Service Center. The unit must be accompanied by a detailed explanation of the symptoms of the failure. You must provide proof of date-of-purchase before the unit is serviced.

This is a transferable manufacturer warranty, which covers the instrument two years from the original purchase date, regardless of the owner.

Items excluded from the warranty are non-rechargeable batteries, accessories that are not standard equipment, shipping / handling costs outside the continental USA, Special Delivery costs (Air Freight, Next Day, 2nd Day, Packaging Services, etc.) and all shipping / handling costs inside the continental USA 90 days after purchase.

White's registers your purchase only if the Sales Registration Card is filled out and returned to the factory address by your dealer, soon after original purchase for the purpose of recording this information, and keeping you up-to-date regarding White's ongoing research & development.

The warranty does not cover damage caused by accident, misuse, neglect, alterations, modifications, unauthorized service, or prolonged exposure to corrosive compounds, including salt.

Duration of any implied warranty (e.g., merchantability and fitness for a particular purpose) shall not be longer than the stated warranty. Neither the manufacturer or the retailer shall be liable for any incidental or consequential damages. Some states however, do not allow the limitation on the length of implied warranties, or the exclusion of incidental or consequential damages. Therefore, the above limitations may not apply to you.

In addition, the stated warranty gives you specific legal rights, and you may have other rights which vary from state-to-state.

The foregoing is the only warranty provided by White's as the manufacturer of your metal detector. Any "extended warranty" period beyond two years, which may be provided by a Dealer or other third party on your detector, may be without White's authority involvement and consent, and might not be honored by White's Electronics, Inc.

Warranty Transfer

If for any reason you should sell your BeachHunter 300 prior to the date the warranty expires, the remaining warranty is transferable.

Simply fill out the following information, seal it in a stamped envelope, and send it to **White's Electronics, 1011 Pleasant Valley Road, Sweet Home, Oregon 97386**. The remaining warranty period will then be available to the new owner.

The Warranty Statement applies to both the original owner as well as the second owner.



WARRANTY TRANSFER

Original Owner:

Name: _____

Address (Which appears on the original warranty card):

Instrument Serial Number: _____

Original Purchase Date: _____

New Owner:

Name: _____

Address: _____

Comments: _____

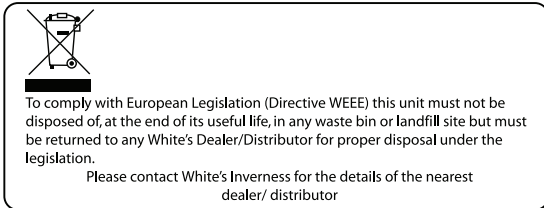

**WHITE'S ELECTRONICS (UK) Ltd.
After Sales Service
LIMITED WARRANTY STATEMENT**

**The serial number which is unique to your unit is on a white label inside the battery compartment.
Please quote this number on any correspondence regarding your detector.**

White's Electronics has always been concerned with the absolute quality of their mineral/metal detectors. Service after the sales is of extreme importance to us and we always do our utmost to ensure that customers are satisfied with our units. If your unit should require servicing or repair, simply return it to us at the factory in Inverness and we shall carry out the necessary work for you.

Any work carried out by unauthorized persons will automatically nullify the warranty.

If within two years (24 months) from the original date of purchase, your White's detector fails due to defects in either material or workmanship, White's Electronics (UK) Ltd. will repair or replace at its option, all necessary parts without charge for parts or labor.

Simply return the detector to our factory in Inverness, Scotland, giving details of the faults.

Items excluded from the warranty are non-rechargeable batteries and other accessories.

The warranty is not valid unless the Warranty Registration Card is returned to the factory address within 10 days of the original purchase for the purpose of recording that date, which is the actual commencement date of the warranty.

This warranty does not cover damage to the detector caused by accident, misuse, neglect, alterations, modifications or unauthorized service.

Duration of any implied warranties (e.g., merchantability and fitness for a particular purpose) shall not be longer than the stated warranty.

Neither the manufacturer nor the retailer shall be liable for any incidental or consequential damages resulting from defects or failures of the instrument to perform.

This warranty does not affect your statutory legal rights.

**White's Electronics (UK) Ltd
35 Harbour Road ~ Inverness ~ Scotland ~ IV1 1UA
Telephone: (01463) 223456 Fax: (01463) 224048
Email: sales@whelects.demon.co.uk.
Web site: www.whites.co.uk**

Warranty Transfer

If for any reason you should sell your White's detector prior to the date the warranty expires, the remaining warranty may be transferable.

Simply fill out the following information, and send it to **White's Electronics, (UK) Ltd., 35 Harbour Road, Inverness, Scotland, IV1 1UA.** White's will then advise you what, if any Warranty is available.

The Warranty Statement must be completed with Serial number and information on previous and new owners.



WARRANTY TRANSFER

Original Owner:

Name: _____

Address (as on original warranty card):

Serial Number: _____

New Owner:

Name: _____

Address: _____

Tel: _____ Email: _____

©White's Electronics, Inc.