

SCHONSTEDT®

Loki Pipe & Cable Locators

User guide

90/UG114INT



CONTRACTOR
MODEL

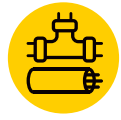

UTILITIES
MODEL



Loki

SPX®

IMPORTANT SAFETY NOTICE



Risk of property damage, death, or serious injury may result if buried pipes and cables are not properly located before digging.



Read and follow all instructions and warnings in this user guide before using the Loki receiver and transmitter.



Regularly check your Loki receiver and transmitter, in all modes, over a cable that gives a response you are familiar with.



Some power cables DO NOT radiate detectable power signals.



Power signals may not be present. It is advisable to use the transmitter whenever searching for pipes and cables.



Do not use the Loki receiver depth estimation function to decide if mechanical digging over a buried pipe/cable is appropriate.



ShallowAlert™ may not activate, even if a live power cable is present.



Keep mobile phones away from cable and pipe locators when in operation. Minimum distance 24"/60cm is recommended.



The Loki receiver cannot indicate whether a signal comes from a single pipe/cable or from several cables or pipes bundled or buried in close proximity to each other.



It is recommended that the Loki receiver and transmitter are serviced at least once a year and have their calibration validated using Schonstedt approved test equipment. Schonstedt will accept no responsibility for repairs carried out by unauthorized repairers.



Even if using a Loki receiver and transmitter, ALWAYS DIG WITH CAUTION.

Call 1-800-999-8280 for questions regarding the proper use, maintenance, and repair of the Loki receiver and transmitter.

Table of Contents

Two Models of Loki	2
Receiver Comparison Table	3
Transmitter Comparison Table	3
Receiver Controls	4
Transmitter Controls	5
Features	6
Using the Receiver	7
Cable Location Using the Transmitter	10
Locating a Sonde	13
Live Plug Connector Procedure	17
FlexiTrace™ to locate non-metallic utilities	17
Service and Maintenance	18
Battery Replacement	19
Product Specifications	20
Warranty	21
Compliance Information	23

Loki Models

Two Loki models are available. The models are designed around the needs of contractors and utility companies who need to detect utilities for safe and efficient excavation and repair.

Contractor Model

Optimized for excavation and construction contractors, the contractor model has 512 Hz, 8 kHz and 131 kHz frequencies built within the Loki transmitter. The higher frequency 131 kHz can be used to find well-insulated, high impedance utilities such as twisted-pair telecom cables or insulated pipe joints. A lower frequency of 512 Hz is also built in to support the long range locating of lower impedance cables, such as power lines.

OPTIMIZED FOR
CONTRACTORS

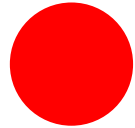

Utilities Model

Built for the challenge of detecting and tracing buried water/drain pipes and telecom ducts, the low 512 Hz frequency can be used to trace metallic pipes. The higher 82 kHz frequency can support the detection of jointed pipes, non-metallic pipes and ducts (when there's a metallic trace wire). The utility model can also be used to locate multiple sonde frequencies.

OPTIMIZED FOR
UTILITIES

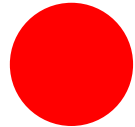

Loki Receivers

Receiver Functions		Contractor	Utilities
Active locate frequencies:	512 Hz	•	•
	8 kHz	•	•
	82 kHz		•
	131 kHz	•	
Inductive frequencies:	8 kHz	•	•
	82 kHz		•
	131 kHz	•	
Sonde frequencies:	512 Hz	•	•
	8 kHz		•
	33 kHz		•
Passive locate modes:	Power	•	•
Dual Mode:	Simultaneously searches for and identifies Transmitter and Power signals	•	•
Gain control:	Manual gain	•	•
ShallowAlert™:	Audio and visual warning when a cable or pipe less than 12" deep is detected. Operates in Active and Passive locating modes.	•	•
NoiseProtect™:	Automatically manages the system gain to compensate for strong signals, e.g. from mains power or substations, to enable accurate locating.	•	•

Loki Transmitters

	Contractor	Utilities
Induction 8 kHz	•	•
Induction 82 kHz		•
Induction 131 kHz	•	
Direct Connect 512 Hz	•	•
Direct Connect 8 kHz	•	•
Direct Connect 82 kHz		•
Direct Connect 131 kHz	•	

Loki Receiver

1. On/Off Trigger.
Press and hold to use the Loki receiver.
2. LCD Screen with automatic depth readout and frequency selection button.
3. Loudspeaker.
Detachable speaker for use in noisy environments.
4. Sensitivity Control.
5. Mode Selector Switch.
6. Battery compartment.



Screen Icons

The Loki receiver's screen displays the following features:

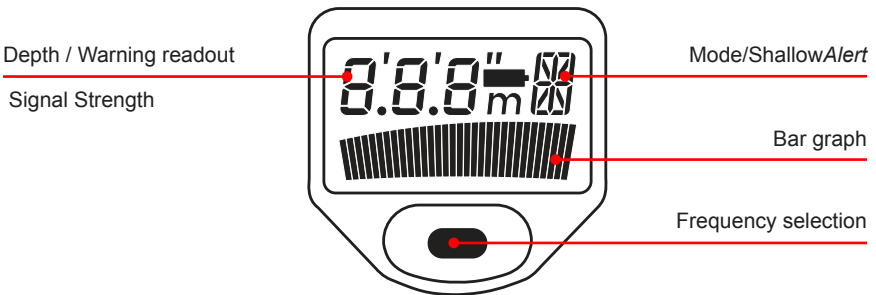

Speaker

When using the Loki receiver in noisy environments, the speaker can be detached and held closer to the ear.

⚠ To avoid excessive noise exposure, hold the speaker no closer than 6" (15 cm) from the ear. Prolonged use in this position should be avoided.

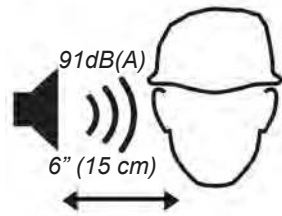

Loki Transmitter

The Loki transmitter is a general purpose, 1 Watt, transmitter that provides three locatable frequencies, two induction frequencies and two signal strengths. By default, the Loki Transmitter induces a signal directly into the ground.

1. **On/Off/Frequency Selector.** LEDs indicate which frequency has been selected.

- a. First press switches the transmitter on and selects the lowest locate frequency.



NOTE: the lowest frequency is only available for direct connections and will not work in induction mode.

- b. Second and third presses select the mid and highest frequencies.
- c. Fourth press turns the transmitter off.

2. **Signal Boost**

Press to boost the locate signal strength from low to high signal strength. LEDs indicate which power level is active. Press again to return to standard power.

3. **Accessory Socket**

Connects cables or optional accessories such as the Signal Clamp, Direct connection lead or Live Plug Connector.

When connected, induction mode is disabled. A loudspeaker emits a pulsing tone to indicate sufficient battery charge and a satisfactory direct connection.

4. **Battery Access Panel.** When no tone is audible the batteries must be replaced.

5. **Arrows**

The arrows on the top panel label indicate the required transmitter alignment above the pipe or cable when using Induction mode.

The arrows and the pipe or cable must be parallel. Alignment is not required when the transmitter is in Direct Connect mode.

6. Connecting Accessories to the Transmitter

When connecting direct connect leads or a clamp to the transmitter, lift the accessory connector cover, align the arrows on the leads/clamp connector with the transmitter label, and push until fully inserted. To remove, pull on the black part of the connector. Pulling on the leads or clamp to remove may cause damage to the accessory.



Note: Turn off the Loki transmitter and remove any cables or accessories before changing batteries

Features

Depth Measurement

The Loki receiver will automatically measure and display the depth in Power, Transmitter and Sonde modes.

Note: The Loki receiver does not measure depth in Dual mode.

Method: Locate the utility as follows. Hold the Loki receiver still and vertically centred above the detected line and across the line of the pipe/cable.

Note: A depth measurement will not be displayed where environmental conditions are poor (e.g. weak signal or interference).

The measurement is to the centre of the pipe/cable or to the centre of the sonde, which may rest at the bottom of the pipe.

Do not use the depth measurement function to decide if mechanical digging is appropriate.

NoiseProtect™

All Loki receivers incorporate NoiseProtect™, a powerful signal-processing tool that identifies and automatically rejects electrical interference that may otherwise overload the Loki receiver's electronics. NoiseProtect™ allows the operator to locate pipes and cables in electrically noisy environments such as near power sub stations or near overhead high-voltage cables. Note that NoiseProtect™ will not overcome very high levels of interference. In this situation the Signal Overload Warning will appear (see Warnings).

ShallowAlert™

 The ShallowAlert™ feature warns the operator of shallow pipes and cables. When a shallow cable or pipe is detected (in any mode), ShallowAlert™ flashes an asterisk and sounds a distinctive warbling audio tone.

Using the Loki receiver

Mode Selection

Loki models are equipped with four locate modes;

Dual mode

Dual mode detects the Transmitter and Power signals simultaneously. To select Dual mode, rotate the function switch until the LCD displays a D icon. The sensitivity control adjusts the Power and Transmitter signal levels simultaneously.

Power mode

Power mode detects power signals radiated by loaded power cables. To select Power mode, rotate the function switch until the LCD displays a P icon.

Transmitter mode

Transmitter mode detects the locate signals produced by a Transmitter. There are various ways of applying the Transmitter signal, which is the most reliable way to detect a pipe or cable. To select Transmitter mode, rotate the function switch until the LCD displays a T icon.

Sonde mode

Sonde mode detects the locate signals produced by a Sonde. To select Sonde mode, rotate the function switch until the LCD displays an S icon.

Getting Started

1. Grip the Loki receiver's handle. Press and hold the trigger and listen for the bleep indicating the batteries are OK. Replace both batteries if there is no bleep or if the battery icon is flashing.
2. Select the appropriate mode.
3. Hold the Loki receiver with the blade vertical and with the lower edge just above the ground. Do not swing it or tilt it more than a few degrees from the vertical.

Swinging the Loki locator will affect locate accuracy.

Operation

Sweep the site holding the Loki receiver upright at your side. Continue the sweep beyond the perimeter of the site. The presence of a buried pipe or cable will be indicated by a tone emitted from the loudspeaker and a kick on the LCD's bar graph.

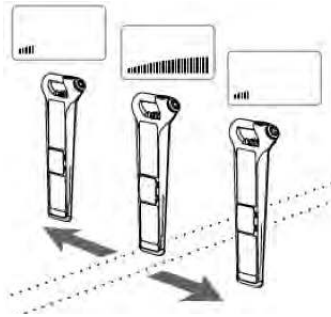

Keep the Loki receiver blade vertical and move slowly backwards and forwards over the suspected pipe/ cable. Reduce the sensitivity for a narrower response; this will allow you to pinpoint the pipe or cable. With the Loki receiver use the meter deflection to aid pinpointing. Maximum meter deflection and audible volume from the speaker will indicate the position of the pipe or cable.

Determining a cable or pipe's direction

When directly over the pipe/cable and with the sensitivity level set for a narrow response, rotate the Loki receiver on its axis until the signal minimum is found. The Loki receiver is directly in line with it when the bar graph and audio are at a minimum.

Check for accuracy by varying the sensitivity control whilst rotating the Loki receiver.

Trace the pipe/cable, keeping the Loki receiver vertical and moving it steadily from side to side. Follow the line of the buried pipe or cable, marking it as required.

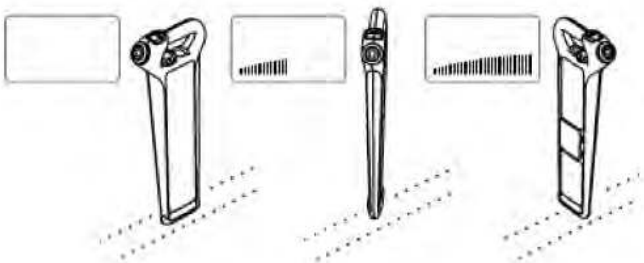

Scanning an area before digging

An initial sweep is recommended before carrying out a detailed scan.

1. Turn the function switch to dual mode to sweep the area for cables or pipes radiating transmitter and power signals.
2. Turn the sensitivity control to maximum.
3. If the signal bar graph does not move from maximum, reduce the sensitivity control so that the bar graph is half way before starting.
4. Sweep the area to be excavated. Begin by walking the perimeter of the proposed excavation area, moving across the width in parallel sweeps around 0.5 meters apart. Position the Loki transmitter as shown.
5. Sweep across the width of the excavation site, moving up the length. Position the Loki transmitter as shown.
6. If a cable or pipe is located, first establish the direction of the cable or pipe, then trace it across the area to be excavated, marking it if required.
7. Resume sweeping over the excavation site.

Note that sometimes the signal may be re-radiated from other pipes or cables.

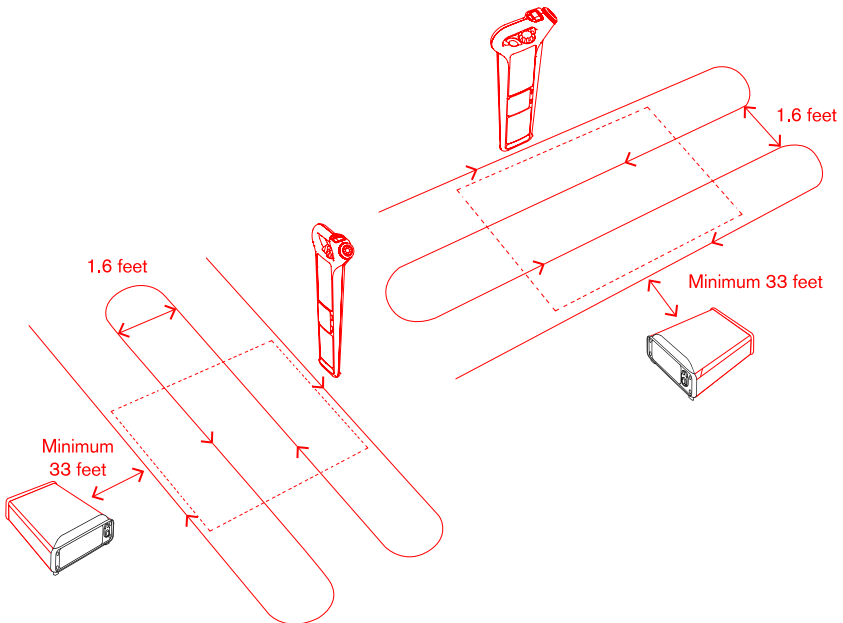

Cable location using the Loki transmitter

The Loki transmitter is used to actively apply a locate signal to cables or metallic pipes. This signal can be traced using the Loki receiver in either Transmitter (T) or Dual mode (D).

Note: Use of the Loki transmitter is strongly recommended, as passive power signals from pipes and cables may not be present, or detectable, on all cables and pipes.

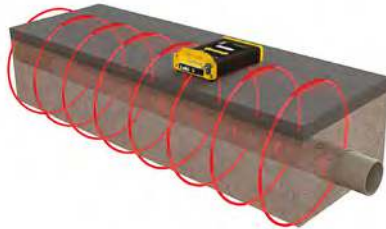

Induction

The Loki transmitter has an internal aerial that will induce a signal onto a line (or lines) directly below it. This is useful when you do not have direct access to the line. Generally, induction is only effective to depths of 6' 6" (2m).

Note that the induction mode is indiscriminate and will apply a signal to all pipes/cables within its range. Induction is only available with frequencies 8 kHz and above.

Induction Procedure

1. Place the transmitter over the approximate position of the underground utility with arrows pointing parallel to its path.
2. Set the Loki receiver and Loki transmitter to the same active frequency.
3. Set the Loki receiver's sensitivity to 100%.
4. Start locating the line at least 33 feet (10m) away from the transmitter.
5. Mark the ground when the Loki receiver detects any signal spike.

Note: Induction cannot apply a signal to a line below reinforced concrete.

Note: The Loki receiver may detect the transmitter signal directly from the transmitter rather than the target line, so do not attempt depth measurements within 10 meters of the Loki transmitter.

To check if you are detecting a signal from the Loki Transmitter, point the Loki receiver directly at the Loki transmitter. If the Loki receiver's signal strength increases, either reduce the Loki transmitter power or increase the distance between the Loki receiver and Loki transmitter. If the signal strength decreases, the signal is from the buried line.

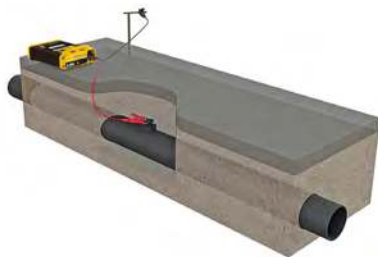

Direct connection

⚠ Connection to a power cable sheath should only be undertaken by qualified personnel.

Direct Connection is an effective way to apply the Loki transmitter locate signal to a specific cable or pipe network so that it can be traced from above ground. Connections can be made to any metallic part of the pipe or cable such as valves, meters, junction boxes, street lights, pipeline markers or other access points.

Direct Connection Procedure

1. With the Loki transmitter switched off, plug the Direct Connect lead into the accessory socket.
2. Attach the red lead to the pipe or cable (if necessary, clean the connection point to ensure a good electrical contact). If the jaws of the clip do not open far enough, and if the connection point is a suitable material, use the supplied magnet.
3. Connect the black lead to the earth stake which should be secured in the ground 3 – 4m away from, and at right angles to the target line.

Alternatively the black lead may be clipped to a valve box, manhole cover or another earthed point. Use the earth spool lead to extend the earth connection if necessary.

4. Switch the Loki transmitter on. A good connection is indicated by a drop in loudspeaker tone. If there is no tone replace the batteries.
5. Use Loki to scan the area. Start with the Loki transmitter's lowest power setting. A pulsed loudspeaker tone indicates a good connection. If there is no tonal change, check the electrical contacts and the ground. If necessary, change the position of the ground stake or pour water over the ground contact if placed in dry soil or sand. If there is still no change in tone increase the power setting.

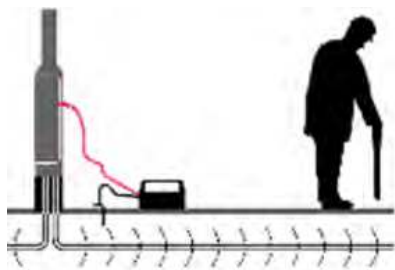

Note: The Loki receiver can detect a signal many times weaker than what is necessary for a transmitter tone change and short distances can be traced without a pulsed tone from the loudspeaker.

To remove the direct connection cable grip the black sleeve on the outside of the plug and ease off the connector.

⚠ Do not pull the wire as this may damage the cable and/or socket.

Regularly check your Loki receiver and Loki transmitter, in all modes over a cable that provides a response that you are familiar with.

Signal Clamp

The optional Signal Clamps can be used to apply a Loki transmitter locate signal safely to a cable or pipe up to 215mm (8.5") in diameter without interrupting the supply. Signal clamps are not suitable for connecting around lampposts.

Signal Clamp Procedure

1. With the Loki transmitter switched off, plug the Clamp lead into the accessory socket.
2. Place the Clamp around the pipe or cable ensuring the jaws are completely closed.
3. Switch the Loki transmitter on, then open and close the Clamp. If the jaws are closing correctly there will be a change in tone as the jaws are closed.

An earth connection from the Loki transmitter is not necessary but optimal signal transfer is only generally achieved if the target line is grounded at both ends. This is usually the case with power cables.

⚠ WARNING! To avoid the risk of electric shock, the signal clamp must be connected to the transmitter before being placed around the pipe or cable.

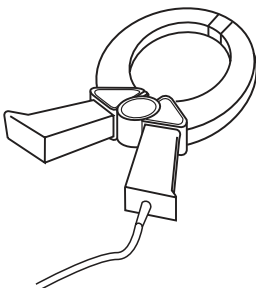

Locating a sonde

The Loki receiver is capable of locating a Schonstedt sonde. Before attempting to locate a sonde ensure that the sonde's batteries are fully charged. Schonstedt recommends using new or fully recharged batteries at the beginning of each day and preferably at the start of each job. Also check that the Loki receiver is operating at the same frequency as the sonde and that they are both working correctly.

To test the Loki receiver and the sonde, position the sonde at a distance equal to its rated depth range from the Loki receiver. Point the Loki receiver at the sonde with its blade parallel to the direction the sonde is travelling.

Check that the bar graph shows more than 50% at high sensitivity

Note: In Sonde Locate mode the blade of the Loki receiver must aligned with the sonde, this is opposite to other line locate methods.



Sonde Procedure

1. Attach the sonde to the rod and insert it into the drain or duct to be mapped. Keep the sonde just in view.
2. Hold the Loki receiver vertically directly over the sonde with the blade in line with the sonde's orientation.
3. Adjust the sensitivity of the Loki receiver to give a bar graph reading between 60-80%.

A sonde radiates a peak field from the centre of its axis with ghost signals at each side of the peak. Move the locator to one side and then along the axis of the sonde forwards and backwards to detect the ghost signals.

Schonstedt recommends locating the ghost signals as finding them confirms the position of the main peak. To lose the ghost signals, reduce the sensitivity of the Loki receiver; this should leave only the main peak signal detectable.

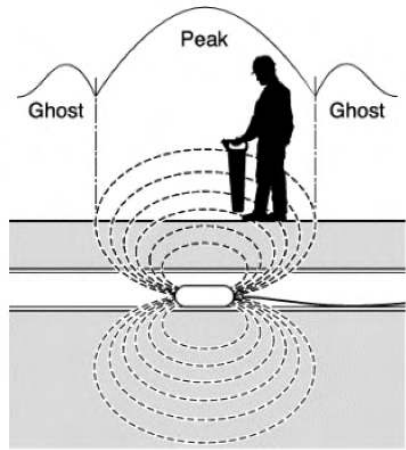

4. With the Loki receiver sensitivity set as desired, propel the sonde along 1m (3-4 feet) and stop. Place the Loki receiver over the estimated position of the sonde.
5. Move the Loki receiver backwards and forwards with the blade's orientation parallel to the sonde.
6. Stop when the bar graph indicates a clear peak.
7. Rotate the Loki receiver as if the blade were a pivot, stop when the display indicates a clear peak response.
8. Move the Loki receiver from side to side until the bar graph indicates a clear peak.
9. When the Loki receiver locates a peak signal, it will automatically calculate the depth of the sonde. Observe the depth reading while moving the Loki receiver from side to side; the lowest reading will be the correct location.
10. Repeat each step in smaller increments with the Loki receiver blade resting on or near the ground. The Loki receiver should now be directly above the sonde with the blade parallel with the sonde; mark this position.
11. Propel the sonde a further 1m (3-4 feet) along the pipe and pinpoint and mark. Repeat the procedure along the route at similar intervals. Note, while tracking the sonde altering the Loki receiver's sensitivity is not required unless the depth of the pipe, or the distance between the Loki receiver and sonde changes.

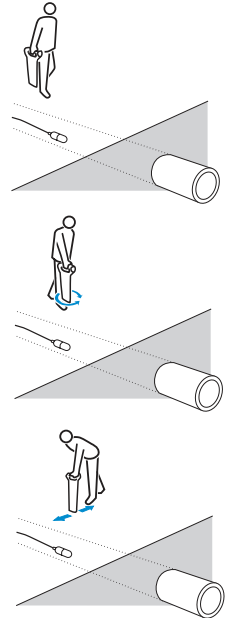

Measuring sonde depth

Pinpoint the sonde as previously described. Then rest the Loki receiver on the ground with the blade's orientation parallel to the orientation of the sonde. Adjust the sensitivity to give a meter reading of 60% to 80% on the LCD's bar graph.

Note that the depth reading is the distance from the bottom of the locator blade to the centre of the sonde and not to the drain or duct being located.

CAUTION: Ensure Depth readings are taken from peak readings.

Depth readings taken from ghost signal position will be incorrect.

Depth measurement is automatic. Depth reading will be displayed when the locator is moved slowly across the sonde. The shallowest depth reading displayed on the LCD is also the correct position directly above the sonde.

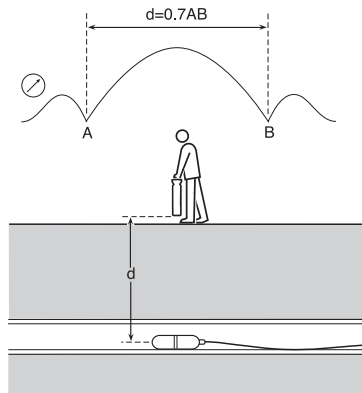

If the signal is too weak or unstable the Loki receiver will not calculate depth. In this case use a more powerful sonde or use the Pinpoint procedure described below.

Pinpoint Procedure

1. Move the locator ahead of the sonde, ensuring the blade's orientation is parallel with the sonde's orientation.
2. Increase the sensitivity slightly to find the ghost signal. Note that between the main peak and ghost there is a Null or minimum.
3. Mark the Null or minimum position for reference.
4. Move behind the sonde and repeat step 1.
5. Find the Null between the ghost and main peak. See points A and B on the diagram on the previous page.
6. The higher the sensitivity of the Loki receiver the sharper the Null's appear.

7. Measure the distance between points A and B and multiply by 0.7 to give an approximate depth measurement.

Warnings

Signal Overload

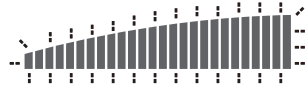

If the Loki receiver is used in areas where very large power signals are present, the signal bar graph will flash. In this condition the sensitivity control and depth function will not operate and you are advised to try lifting the Loki receiver to bring it out of the overloaded condition or use in a different location.

Deactivating

If required the *ShallowAlert™* warnings can be temporarily disabled by pressing and holding the frequency selection button for the duration of the battery test bleep at switch on.

Live Plug Connector

⚠ Do not use the supplied Direct Connect leads to connect to live cables. Use the Live Plug Connector or Live Cable Connector. Failure to do so may result in injury or equipment damage.

⚠ Connection to live power cables should only be undertaken by qualified personnel.

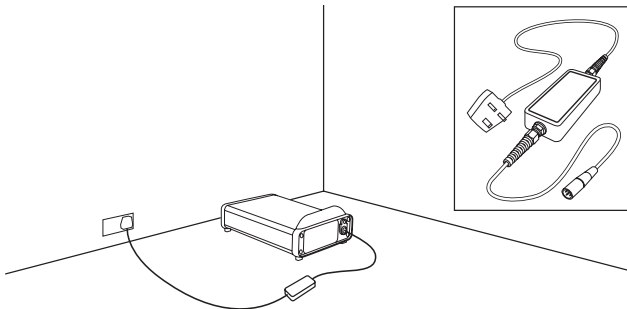

The optional Live Plug Connector applies the transmitter signal to a live domestic power socket and via the domestic wiring system on the service cable and the supply cable in the street. The signal should be detectable on the supply system to a few hundred meters each side of the point of application.

Note: Do not connect the Loki transmitter to live cables without using a Live Plug Connector or Live Cable Connector.

Live Plug Connector Procedure

1. With the Loki transmitter switched off, connect the Live Plug Connector to the Loki transmitter.
2. Connect the Loki Transmitter to the live domestic power socket. Where required switch on the power socket.

Note: The Live Plug Connector provides protection to 250V AC.

3. Sweep the site holding the Loki receiver upright at your side.
4. Continue the sweep beyond the perimeter of the site. The presence of a buried pipe or cable will be indicated by a tone emitted from the loudspeaker and a spike on the LCD's bar graph.
5. Keep the Loki receiver's blade vertical and move slowly backwards and forwards over the pipe/cable. Reduce the sensitivity for a narrower response; this will allow you to pinpoint the pipe/cable.
6. With the Loki receiver use the meter deflection to aid pinpointing. Maximum meter deflection and audible volume from the speaker will indicate the position of the pipe/cable.
7. When directly over the pipe/cable and with the sensitivity level set for a narrow response, rotate the Loki receiver on its axis until the signal minimum is found. The blade is now parallel with the conductor.
8. Trace the pipe/cable beyond the site and mark the position as required.

FlexiTrace™ – to locate non-metallic utilities

FlexiTrace is a 50m (164') or 80m (260') flexible conductive rod with a built-in sonde that can be inserted into non-metallic pipes and ducts to allow them to be located at depths of up to 3m (10') FlexiTrace can be inserted into a pipe or duct as small as 12mm (½") internal diameter, and with bends as tight as 250mm.

To use as a sonde, connect both transmitter leads to the FlexiTrace lugs. In this mode, only the tip of the FlexiTrace will be locatable. To trace the whole length, connect the red transmitter lead to a FlexiTrace terminal and ground the black lead, either to the earth stake or to an appropriate earthing point.

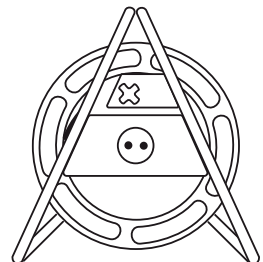

Service and Maintenance

 The Loki receiver and Loki transmitter are designed to require minimal recalibration. However, as with all safety equipment, it is recommended that they are serviced and have their calibration validated using Schonstedt approved test equipment. Schonstedt accepts no responsibility for service, calibration or repairs carried out by non-authorised persons.

Functional test

Schonstedt recommends that you perform a daily functional test on the Loki receiver and Loki transmitter before use. To perform the function test;

1. Place the transmitter on the ground.
2. Switch the Loki Transmitter on and check for an audible sound. If no sound is heard, replace the batteries before use.
3. Switch on the Loki receiver by squeezing the trigger, checking for an initial 'chirp.' A low tone indicates low batteries. If no sound is heard, replace the batteries before use.
4. Rotate the Loki receiver function switch and check that the appropriate icon is displayed in each position of the switch (as per the 'Modes' section earlier on in this guide).
5. Set the Loki receiver and Loki transmitter to the same active frequency.
6. With the Loki receiver in Transmitter mode (T), set the sensitivity at its maximum gain, hold at waist height pointing toward the Loki transmitter with the flattest part of the housing parallel to the ground and check that the Loki receiver can detect the Loki transmitter up to 49' (15m) away with a clearly audible sound.

Replacing batteries

⚠ Do not mix new and old batteries or different types of batteries, as this may cause them to overheat.

Loki Receiver

To replace the batteries, open the access cover using a screwdriver or coin. To open the access cover, gently pry between the cover and the clip on both the top and the bottom latches. Replace the batteries with two D-cell alkaline batteries or equivalent NiMH rechargeable batteries. Close the cover and press firmly near the latches until latched.



← Latched

← Not Latched

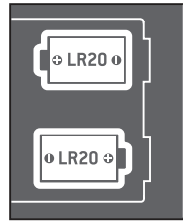

Loki Transmitter

To replace the batteries, unscrew the fastener on the rear panel and replace with four D-cell alkaline batteries. Observe correct battery polarity as indicated on the top-panel label. Close the battery door and turn clockwise until tight.



Product specification

Specifications	
Weight:	Receiver: 4.9 lbs (2.2kg), Transmitter: 4.0 lbs (1.8kg)
Water and dust resistance:	IP54
Audio options:	Tx has built-in water-resistant speaker, generating audio capable of being heard over road traffic. Rx has detachable speaker, doubles as ear piece.
Operating temperature:	-4°F to 122°F (-20°C to 50°C)
Storage temperature:	-4°F to 158°F (-20°C to 70°C)
Dimensions:	Rx: 28" x 9.8" (71cm x 25cm) Tx: 10.8" x 6.9" x 2.4" (27.5cm x 17.5cm x 6cm)
Battery type:	D Cells
Battery run-time:	Rx: 13 hours (alkaline) Tx: 8 - 20 hours depending on mode (alkaline)
Depth accuracy:	Line: 5% 0.3' - 9.8' (0.1m - 3m) Sonde: 5% 0.3' - 16' (0.1m - 4.8m)
Locate accuracy:	+/- 10% of depth
Warranty:	1 year

Warranty

Subject to the conditions set out herein, Schonstedt Instrument Company expressly and exclusively provides the following warranty to original end user buyers of Schonstedt products.

Schonstedt hereby warrants that its products shall be free from defects in material and workmanship for one year starting from point of sale to end customer. Extensions of this warranty period may be available where the same terms and conditions apply.

Statement of warranty conditions

The sole and exclusive warranty for any Schonstedt product found to be defective is repair or replacement of the defective product at Schonstedt's sole discretion. Repaired parts or replacement products will be provided by Schonstedt on an exchange basis and will be either new or refurbished to be functionally equivalent to new.

In the event this exclusive remedy is deemed to have failed of its essential purpose, Schonstedt liability shall not exceed the purchase price of the Schonstedt product. In no event will Schonstedt be liable for any direct, indirect, special, incidental, consequential or punitive damages (including lost profit) whether based on warranty, contract, tort or any other legal theory.

Warranty services will be provided only with the original invoice or sales receipt (indicating the date of purchase, model name and dealer's name) within the warranty period. This warranty covers only the hardware components of the Schonstedt product.

Before a unit is submitted for service or repair, under the terms of this warranty or otherwise, any data stored on the unit should be backed-up to avoid any risk of data loss. Schonstedt will not be responsible for loss or erasure of data storage media or accessories.

Schonstedt is not responsible for transportation costs and risks associated with transportation of the product. The existence of a defect shall be determined by Schonstedt in accordance with procedures established by Schonstedt.

This warranty is in lieu of any other warranty, express or implied, including any implied warranty of merchantability or fitness for a particular purpose.

This warranty does not cover:

- a. Periodic maintenance and repair or parts replacement due to wear and tear.
- b. Consumables (components that are expected to require periodic replacement during the lifetime of a product such as non-rechargeable batteries, bulbs, etc.)
- c. Damage or defects caused by use, operation or treatment of the product inconsistent with its intended use.

- d. Damage or changes to the product as a result of:
 - i. Misuse, including: - treatment resulting in physical, cosmetic or surface damage or changes to the product or damage to liquid crystal displays.
 - ii. Failure to install or use the product for its normal purpose or in accordance with Schonstedt instructions on installation or use.
 - iii. Failure to maintain the product in accordance with Schonstedt instructions on proper maintenance.
 - iv. Installation or use of the product in a manner inconsistent with the technical or safety laws or standards in the country where it is installed or used.
 - v. Virus infections or use of the product with software not provided with the product or incorrectly installed software.
 - vi. The condition of or defects in systems with which the product is used or incorporated except other 'Schonstedt products' designed to be used with the product.
 - vii. Use of the product with accessories, peripheral equipment and other products of a type, condition and standard other than prescribed by Schonstedt.
 - viii. Repair or attempted repair by persons who are not Schonstedt warranted and certified repair houses.
 - ix. Adjustments or adaptations without Schonstedt's prior written consent, including:
 - i. Upgrading the product beyond specifications or features described in the instruction manual, or modifications to the product to conform it to national or local technical or safety standards in countries other than those for which the product was specifically designed and manufactured.
 - x. Neglect e.g. opening of cases where there are no user replaceable parts.
 - xi. Accidents, fire, liquids, chemicals, other substances, flooding, vibrations, excessive heat, improper ventilation, power surges, excess or incorrect supply or input voltage, radiation, electrostatic discharges including lightning, other external forces and impacts.

Compliance Information

United States

FCC Compliance Statement:

This device complies with Part 15 of the FCC rules. Operation is subject to the following two conditions: (1) This device may not cause harmful interference, and (2) this device must accept any interference received, including interference that may cause undesired operation.

Notice To Users:

NOTE: This equipment has been tested and found to comply with the limits for a Class A digital device pursuant to Part 15 of the FCC Rules. These limits are designed to provide reasonable protection against harmful interference when the equipment is operated in a commercial environment. This equipment generates, uses, and can radiate radio frequency energy and, if not installed and used in accordance with the manufacturer's instruction manual, may cause harmful interference with radio communications. Operation of this equipment in a residential area is likely to cause harmful interference, in which case you will be required to correct the interference at your own expense. Modifications: Any modifications made to this equipment not approved by Schonstedt may void the authority granted to the user by the FCC to operate this equipment.

Canada

CAN ICES-003(A) NMB-003(A)

CAN RSS-210(A) CNR-210(A)

Visit www.schonstedt.com

Schonstedt Instrument Company

100 Edmond Road, Kearneysville, WV 25430, USA

Tel: +1 (304) 725-1050 Toll Free: +1 (800) 999-8280

Email: Schonstedt.info@spx.com