

# SeaLion-2

## OPERATION MANUAL

*JW FISHERS MFG INC*

rev 80912



**JW FISHERS MFG INC**  
1953 COUNTY ST.  
E. TAUNTON, MA 02718 USA

(508) 822-7330; (800) 822-4744; FAX (508) 880-8949  
Email: [jwfishers@aol.com](mailto:jwfishers@aol.com) WEB: [www.jwfishers.com](http://www.jwfishers.com)

# SeaLion-2

## Remote Operated Vehicle

### OPERATION AND MAINTENANCE MANUAL

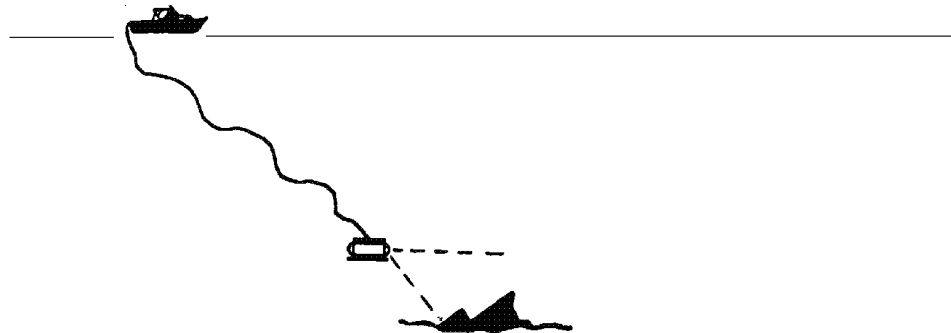

**TABLE OF CONTENTS**

- SeaLion CAUTIONS ..... 4
- SeaLion SPECIFICATIONS ..... 5
- SeaLion COMPONENTS
  - SeaLion ..... 6
  - CABLE ..... 7
  - CONTROL BOX ..... 8
  - CONTROL BOX COVER ..... 8
  - CONTROL BOX CONTROL PANEL ..... 9
  - PS2 CONTROLLER ..... 15
- CABLING THE SeaLion ..... 18
- POWERING UP THE SeaLion ..... 20
- OUT OF WATER TEST ..... 20
- IN WATER BALANCING THE ROV ..... 23
- LAUNCHING AND RETRIEVING THE SeaLion ..... 24
- CONTROL BOX BLOCK DIAGRAM ..... 25
- ROV BLOCK DIAGRAM ..... 26
- MAINTENANCE ..... 27
- WARRANTY ..... 27
- SPARE PARTS ..... 28
- Options:
  - External DVD recorder ..... 29
  - Built in DVR (digital video recorder) ..... 30
  - Manipulator Arm ..... 13
  - Auto Depth ..... 13
  - Distance off Bottom Displayed ..... 13
  - Auto Distance off Bottom ..... 13

## SeaLion-2 Cautions

- ALWAYS PLUG THE CONTROL BOX INTO A GROUND FAULT BREAKER FOR SAFETY. IF AN ELECTRICAL LEAK OCCURS TO THE WATER, THE GROUND FAULT BREAKER WILL TRIP.
- NEVER PLUG THE CONTROL BOX POWER INTO ANY VOLTAGE OTHER THAN 120 VAC (NEVER 220 VAC). IF ONLY 220 VAC IS AVAILABLE A STEP DOWN TRANSFORMER IS NEEDED.
- 120 VAC IS DANGEROUS - DO NOT EXPOSE CONTROL BOX OR ELECTRICAL CONNECTIONS TO WATER.
- AVOID UNNECESSARY ROUGH HANDLING.
- PRIOR TO LAUNCH, CHECK ALL FITTINGS.
- PRIOR TO LAUNCH, AND WITH POWER OFF, ROTATE ALL PROPS ONE TURN BY HAND.
- PROTECT THE MONITOR AND CONTROL BOX FROM THE ELEMENTS.
- KEEP HANDS AND FINGERS CLEAR OF THE PROPELLERS AT ALL TIMES.
- MAKE ELECTRICAL CONNECTIONS ONLY AS SPECIFIED IN THIS MANUAL. DO NOT BYPASS ANY ELECTRICAL SAFETY CIRCUITS (GROUND FAULT).
- READ AND UNDERSTAND THE MANUAL BEFORE MAKING ANY REPAIRS TO THE SeaLion.
- DO NOT OPERATE THE SeaLion OUT OF THE WATER, EXCEPT AS PROVIDED IN THIS MANUAL.
- IF THE LEAK DETECTOR INDICATES A LEAK, REMOVE UNIT FROM THE WATER AS QUICKLY AS POSSIBLE.
- DO NOT LIFT THE UNIT BY ITS UMBILICAL CABLE, LIFT AND LOWER THE SeaLion BY MEANS OF THE HANDLE.
- DO NOT BEND THE UMBILICAL CABLE SHARPLY, A SHARP BEND COULD BREAK AN INTERNAL WIRE IN THE CABLE.
- PLUG CONTROL BOX AND MONITOR INTO A GROUND FAULT OUTLET (ON SHIP).
- BE SURE TO UNPLUG MONITOR FROM CONTROL PANEL BEFORE CLOSING COVER.

## **SPECIFICATIONS**

### **DIMENSIONS/WEIGHTS:**

SeaLion ..... 23L x 16W x 12H inches ..... 43 lbs.  
Control Box ..... 19L x 16W x 8.5H inches ..... 15 lbs.  
Cable ..... .5 inches Dia x 250 to 1,500 feet ..... 30/180 lbs.  
Monitor (built into case) ..... 15 inches

### **PERFORMANCE/DESCRIPTIONS:**

Cameras/Lens ..... CCD color cameras/4mm 50 deg wide angle lens, 90 degree pan and tilt,  
auto iris.  
Monitor ..... 15 inches, high resolution, ultra bright, color.  
Lighting ..... Two 100w tungsten halogen (front).  
..... Ultra bright LED ring (rear).  
Motors ..... Four DC PM type, reversible, variable speed, proportional controlled, 7+lbs.  
thrust each motor, 4 knots.  
Operating Depth ..... 1,000 feet.  
Color ..... Yellow/black.  
Sealing ..... Five separate housings, O-ring sealed, a leak detector in each housing,  
motors use "no maintenance" rotary seals.  
Power Req ..... 120 vac, 8 amps, 900w max.

### **OPTIONS:**

- Up to 1,500 foot cable
- DVR recorder (built-into Control Box)
- External DVD recorder
- Two color side cameras
- On screen display for Time, Date, and GPS
  - Additional sensors to display ROV Compass, Depth and Temp
  - Distance off Bottom Displayed
  - Auto Depth Control
  - Auto Distance off Bottom Control
- Manipulator arm
- Scan-650 scanning sonar
- Attached metal detector (RMD-1)
- Can be computer controlled
- PAL camera and monitor (Europe)
- 220vac (Europe)
- Spare parts kit

## System Components



ROV



Cable



Control Box

The SeaLion-2 system comes complete with the ROV, neutrally buoyant cable, and a control box with a built-in color monitor and PS2 controller.

---

## System Operation

### ROV:



The SeaLion-2 ROV contains two color CCD cameras (one front and one rear) with 4mm (wide angle) lens. The viewing area is 50 degrees. The cameras can be panned and tilted 90 degrees for a total viewing area of 140 degrees horizontal and vertical. Depending on the amount of light, the iris will automatically open and close as required. The cameras have a wide range fixed focus lens. A switch on the control panel selects either front or rear camera, but not both at the same time. The cameras pan and tilt is controlled by buttons on the PS2 controller.

The Sealion-2 has four high performance motors that are variable speed and reversible. The horizontal and vertical motors are controlled by joysticks on the PS2 controller. Each motor housing is independently sealed from the main body and each of the five housings contain a leak detector that informs the operator if any moisture enters the housing.

Front lighting is provided by two 100 watt water cooled halogen bulbs. They are fully adjustable from 0 to 200 watts of lighting. Rear lighting is provided by a ring of Ultra Bright LEDs that are operator controlled for on/off.

## ROV: (continued)



The two skids contain ballast weights that are used to adjust both the balance and buoyancy of the ROV in water. When properly adjusted, the ROV should sit level in the water and should be slightly positive, just positive enough so it does not sink (extra ballast weights are included.)

The ROV is pressure tested to a 1,000 foot depth prior to shipment. Operation of the SeaLion-2 out of water is not recommended. If the **front** lights are operated out of the water for more than 10-15 seconds the water cooled halogen lights will overheat and burn the reflector. If the motors are operated out of the water for more that 5-10 seconds the motor seals will overheat and experience excessive wear. After cabling up the system a short pretest may be made of the lights and motors. The cameras and rear LED lights can or course be operated out of water. At all times caution is advised in handling the propellers.

---

## Cable:



The umbilical cable connects the ROV to the control box. The cable is neutrally buoyant and has a connector on both ends. The system comes standard with a 250 foot cable. Additional cable can be ordered up to a total length of 1,500 feet (do not exceed this total length.) When additional cable is ordered it comes with a connector on both ends and performs as an extension cord. The additional cable installs between the 250 foot cable and the ROV.

The umbilical cable is approximately .5 inches in dia and contains nine wires: a coax for the video signal, two twisted pairs for transmitting and receiving control signals to the ROV, a twisted pair for power to the ROV and a spare twisted pair for options (metal detector, scanning sonar, etc). It is important that the cable be protected against damage.

## Control Box:

The Control Box is the nerve center of the SeaLion-2 system. The Control Panel (lower half) contains all the necessary switches and indicators to control and monitor the ROV. The umbilical cable to the ROV is connected to the control panel. Power and control signals are passed from the control panel through this cable to the ROV.

An off-the-shelf PS2 controller (supplied), plugs into the control panel and controls the ROV's: lights, motors, and camera movement. Wireless PS2 controllers can also be used.

The top half of the control panel contains the 15" ultra bright monitor which displays the live video feed from the front or rear ROV cameras (switch selectable on the control panel.)

The control box can be split apart at the hinge, by removing two pins, allowing the upper and lower parts of the control box to be separated by a short distance.



## Control Box Cover:

The control box cover contains the built-in 15" ultra bright monitor, a speaker, and a volume control.

**Volume Control** - Adjusts the volume level from the speaker when playing back a video on the monitor from an optional integrated DVR.)

**Speaker** - Audio, during playback, from the optional integrated DVR that is playing back a video on the monitor

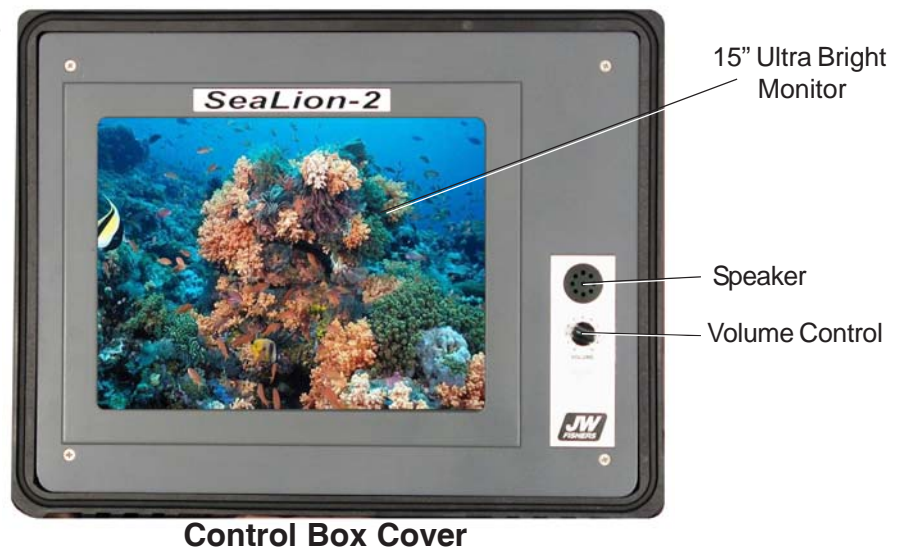



## Control Box: (continued)

### Control Box Control Panel:

The Control Panel contains all the necessary switches and indicators to control and monitor the SeaLion-2.

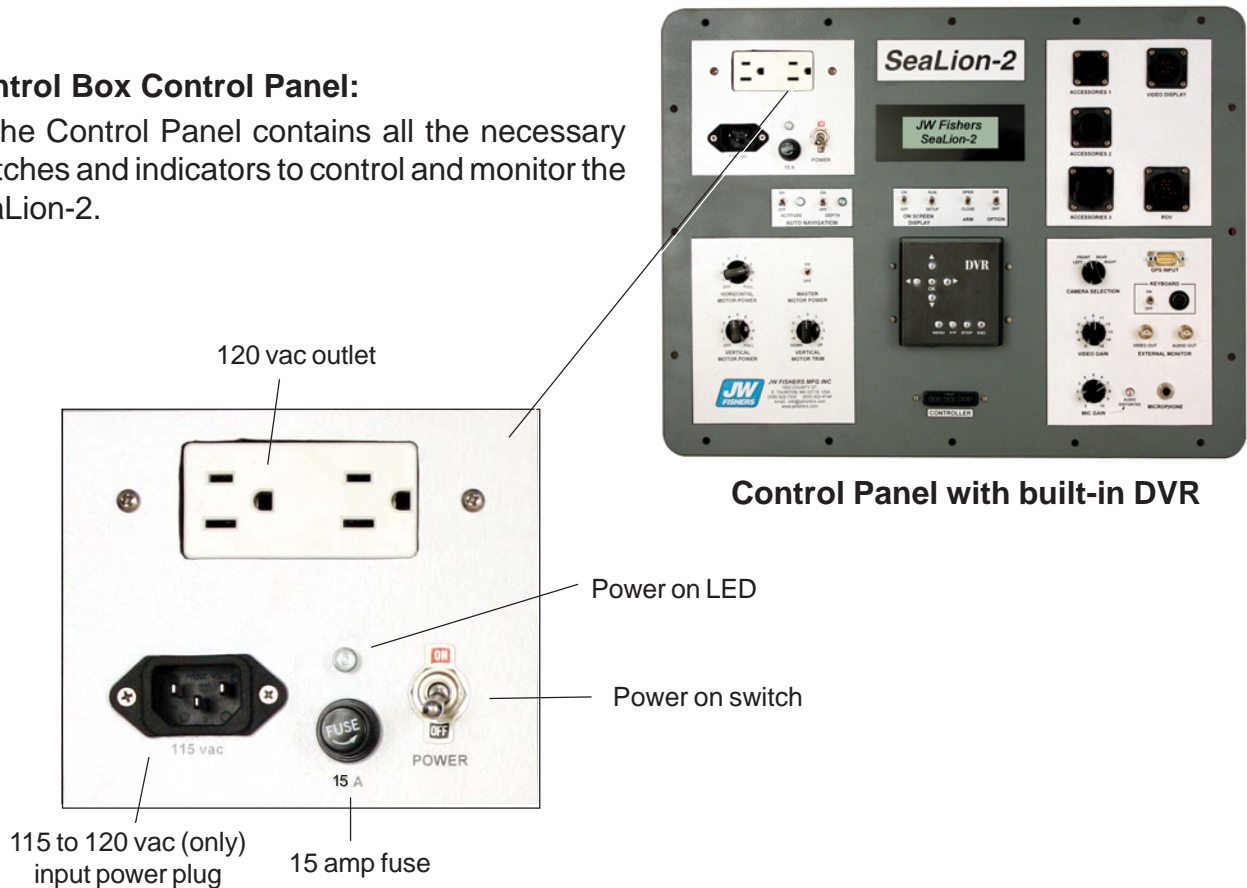

Control Panel with built-in DVR

### Power Input Area:

115-120 vac input power - from generator or ships power. For safety, be sure to plug into a "ground fault breaker". If operating from 220 vac, be sure to use a stepdown transformer (220 to 120 vac).

- **Fuse** - 15 amp main fuse. All power goes through this fuse. When open removes power from the system.
- **Power on switch** - Applies power to the system. All power goes through this switch.
- **Power on LED** - Illuminates when power is on.
- **120 vac outlet** - Can be used to power a second monitor or recorder.
- **120 vac input power plug** - Power cord (supplied) plugs into this connector and power is supplied to the system.

### LCD Readout:

The LCD readout displays data regarding the status of the system including: moisture in any housing, pan and tilt angles of the cameras, any motor overcurrent problems, and any error or communication problem.



LCD Readout

## Control Box: (continued)

### Control Box Control Panel: (continued)

The Control Panel contains all the necessary switches and indicators to control and monitor the SeaLion-2.

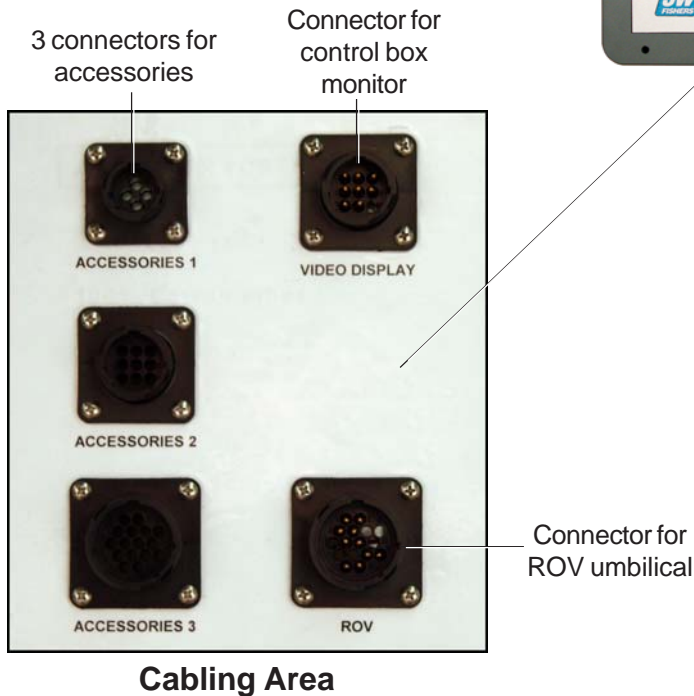

### Cabling Area:

The umbilical cable from the ROV, the video signal cable to the monitor in the cover, and some accessories plug into this area.

- **Monitor** - a short cable connecting the control panel to the built in monitor in the cover. The cable carries the video signal and monitor power.
- **ROV** - the umbilical cable from the ROV.
- **Accessories** - many different accessories can be added to the ROV. The accessory connectors enable the operator to interface with the add-on accessory. The remote metal detector (RMD-1) and scanning sonar (Scan-650) are two examples.

## Control Box: (continued)

### Control Box Control Panel: (continued)

The Control Panel contains all the necessary switches and indicators to control and monitor the SeaLion-2.

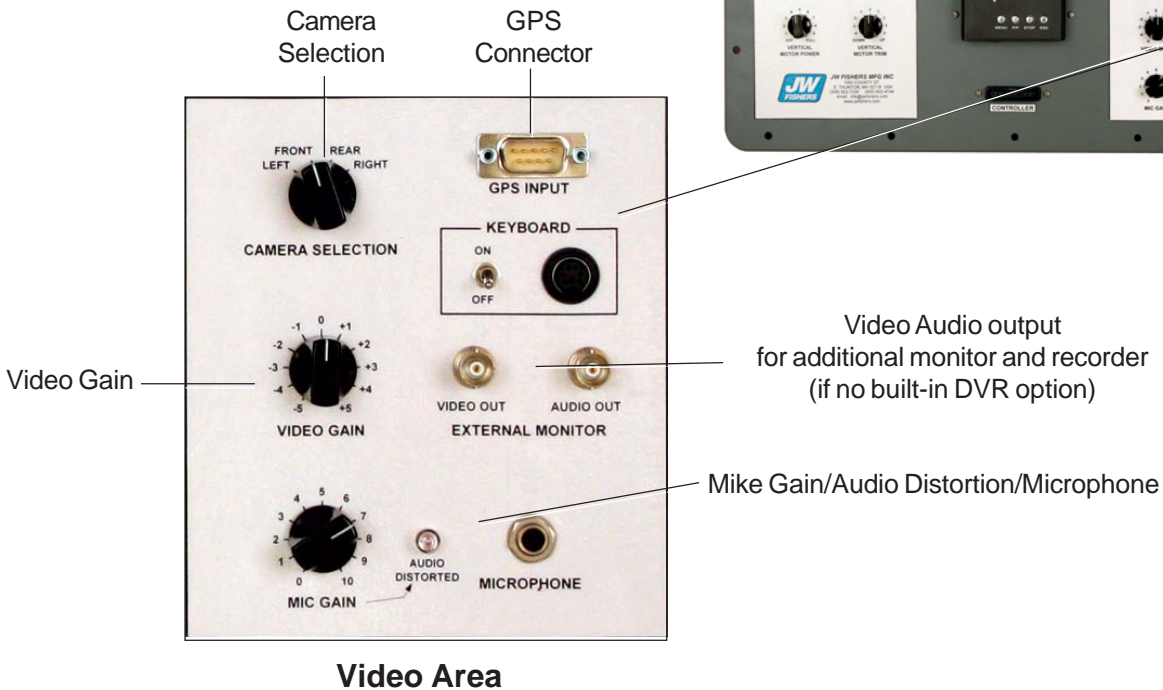

### Video Area:

The video area contains the camera selection switch and controls and connectors for the video and audio signals. It also contains the input connectors for a keyboard and the boat's GPS which are used with the on-screen-display option.

- **Camera Selection** - a four position switch which selects which camera is to be displayed on the monitor and controlled by the joysticks.
  - Left... Turns on the optional left camera and its built-in light ring.
  - Front... Turns on the front camera.
  - Rear... Turns on the rear camera.
  - Right... Turns on the optional right camera and its built-in light ring.
- **Video Gain** - before the video signal is sent to the monitor(s) it goes through a video amplifier. The gain is adjustable. When the water clarity is poor, adjusting the gain of the signal can have a significant impact on the quality of the displayed image.
- **Mike Gain/Audio Distortion/Microphone** - If you are recording the video from the ROV you can also record audio with the video. The loudness of the recorded audio is controlled by the Mike Gain knob. If the mike gain is set too high the audio Distortion led will flash while you are talking into the microphone. The microphone (not supplied) plugs into the microphone connector.

## Control Box: (continued)

### Control Box Control Panel: (continued)

The Control Panel contains all the necessary switches and indicators to control and monitor the SeaLion-2.

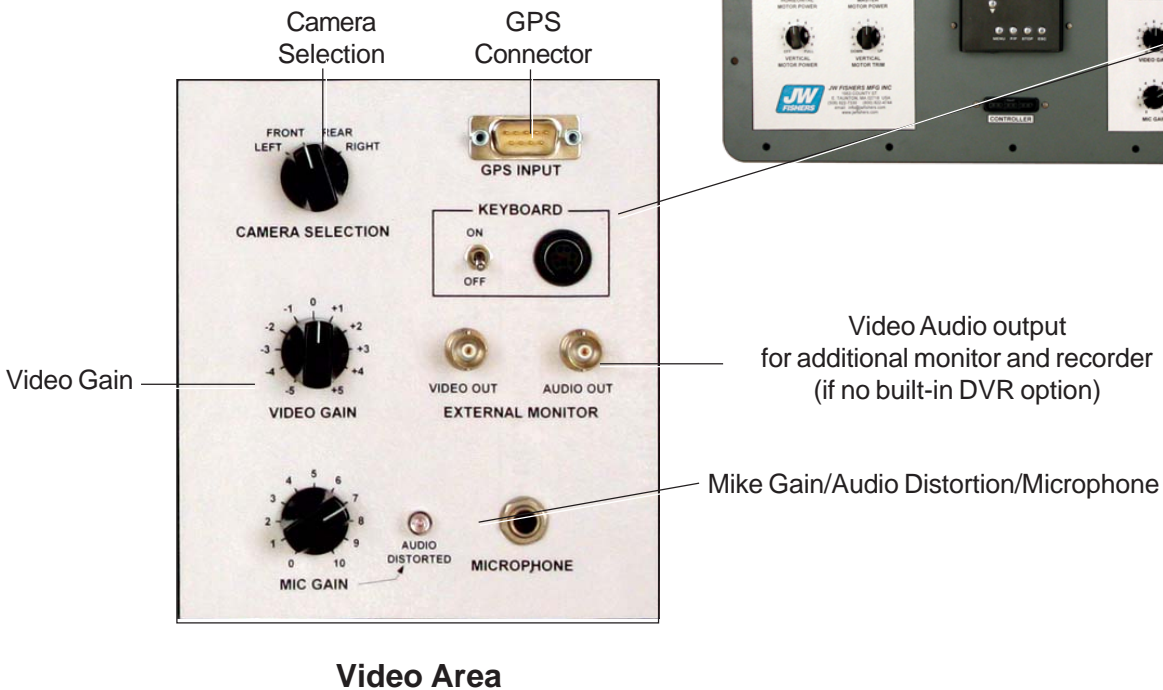

Video Audio output  
for additional monitor and recorder  
(if no built-in DVR option)

Mike Gain/Audio Distortion/Microphone

### Video Area

### Video Area: (continued)

The video area contains the camera selection switch and controls and connectors for the video and audio signals. It also contains the input connector for the boat's GPS which is used with the On Screen Display option.

- **Audio and Video out** - These connectors are not used unless you are recording (recorder not supplied) or have an additional monitor.

- Video and audio out....use these two connectors to cable to an external recorder or to a second monitor.

- **GPS** - The boat's GPS connects to the connector. The boat's GPS position will be overlaid on the video if the On Screen Display option was purchased. .

- **Keyboard (not provided) input displayed and recorded option** - With this option a switch and connector is provided on the front panel that enables a standard PS/2 PC keyboard (not provided) to input data. The data is displayed on the screen. This option requires the On Screen Display option.

## Control Box: (continued)

### Control Box Control Panel: (continued)

The Control Panel contains all the necessary switches and indicators to control and monitor the SeaLion-2.

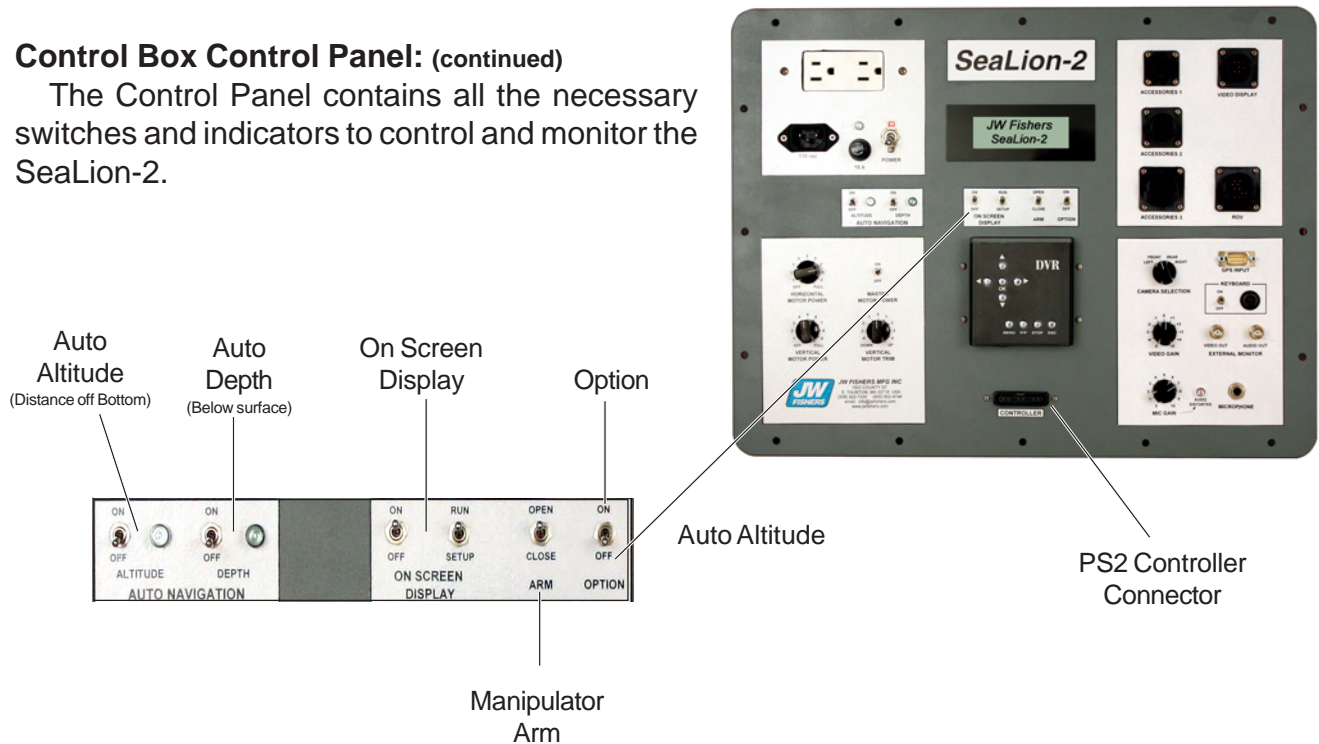

### Option Area Layout

#### Option Area:

The option area contains switches and indicators for some options.

- **On Screen Display** - When the switch is turned on; time, date, water temperature at ROV, depth, and compass heading is overlaid on the video. If the video is being recorded the overlay is recorded with the video. A second switch "setup" is used to customize the overlay.
- **Arm**- a manipulator arm is available. The switch controls the open or close position of the arm.
- **Option** - spare switch for future option.
- **Auto Depth** - When the switch is turned on, the LED illuminates and the ROV will maintain the approximate depth below surface by automatically controlling the vertical motors.
- **Auto Altitude** - When the switch is turned on, the LED illuminates and the ROV will maintain the approximate distance off bottom by automatically controlling the vertical motors.

#### PS2 Controller Connector:

An off-the-shelf PS2 controller (supplied) plugs into the control panel and controls many of the operations of the ROV including: motors, lights, and camera movement. Wireless PS2 controllers are available and can also be used.



## Control Box: (continued)

### Control Box Control Panel: (continued)

The Control Panel contains all the necessary switches and indicators to control and monitor the SeaLion-2.

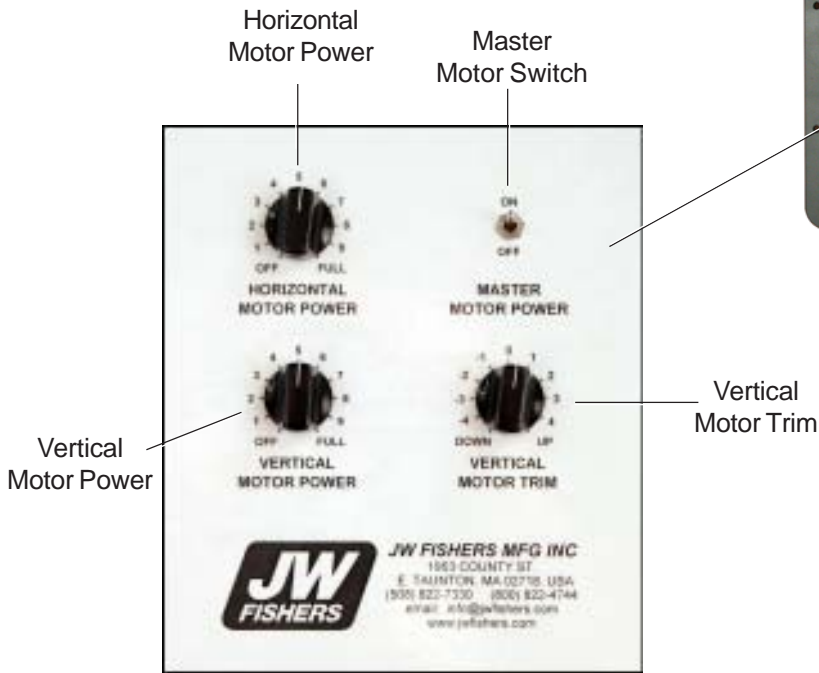

**Motor Control Area**

### Motor Control Area:

Contains switches and controls for the motors.

- **Horizontal Motor Power** - this adjustment controls the amount of power that the horizontal motor joystick can send down to the ROV. The adjustment goes from 0 to Full power. In most cases this control is set to Full. However there are times when this control should be set to a reduced power setting (operating in a small area, training in a pool, operating very close to a object).
- **Vertical Motor Power** - this adjustment controls the amount of power that the vertical motor joystick can send down to the ROV. The adjustment goes from 0 to Full power. In most cases this control is set to Full. However there are times when this control should be set to a reduced power setting (operating in a small area, training in a pool, operating very close to a object).
- **Vertical Motor Trim** - this adjustment provides trim to the vertical motors so even if the vertical joystick is centered (not being used) the motors can be set to run (up or down slowly). The adjustment goes from 0 to +/- 4. Commonly used to hold vertical position or when sitting on the bottom (vertical joystick not needed).
- **Master Motor Power** - an on/off switch that when in the off position removes all power from both vertical and horizontal motors. Normally this switch is left on. When working on the system out of water the Master Motor Power switch should be turned off for safety reasons.

**Control Box: (continued)**

**Control Box Control Panel: (continued)**

The Control Panel contains all the necessary switches and indicators to control and monitor the SeaLion-2.



**PS2 Controller:**

An off-the-shelf PS2 controller (supplied), plugs into the control panel and controls the ROV's: lights, motors, and camera movement. Wireless PS2 controllers can also be used.

PS2 Controller

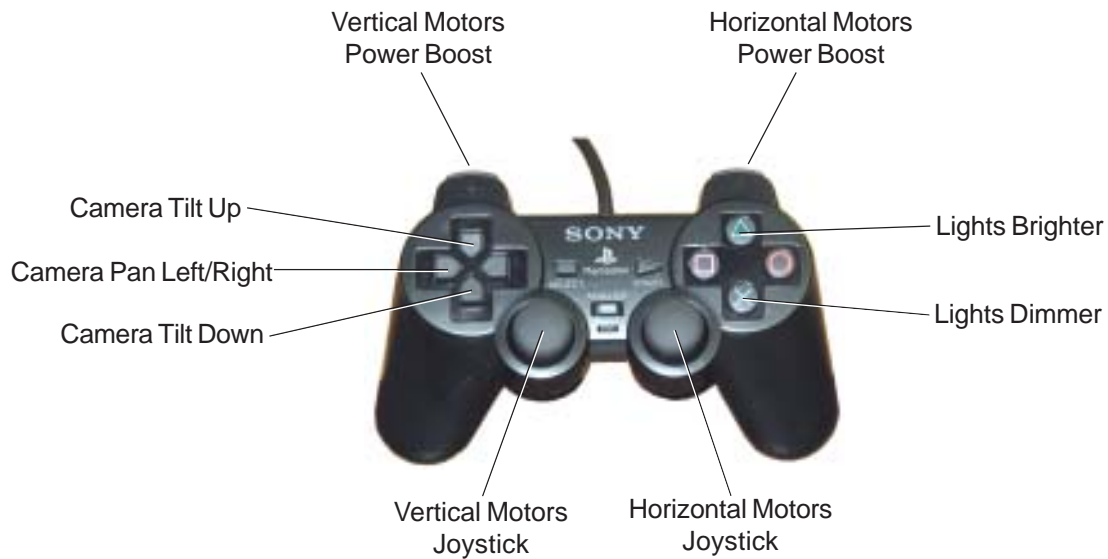

**PS2 Back View**



## Control Box: (continued)

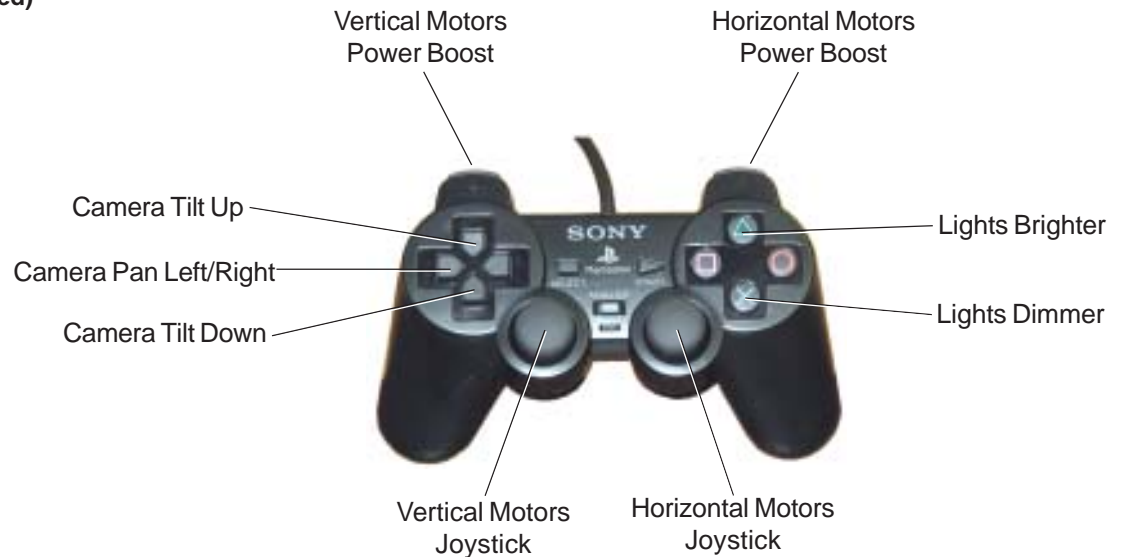

## PS2 Controller: (continued)

An off-the-shelf PS2 controller (supplied), plugs into the control panel and controls the ROV's: lights, motors, and camera movement. Wireless PS2 controllers can also be used

- **Camera Pan and Tilt** - two buttons control the cameras up/down movement and two buttons control the left right movement. If the button is held down the camera will continue to move until it reaches its limit in that direction.
- **Lights** - two buttons control the lights. The brightness of the front lights are adjustable from 0 to 200 watts (**caution** - do not leave front lights on out of water, a quick test is ok). Each time the top button is pressed the lights get brighter. Each time the lower button is pressed the lights get dimmer. If the button is pressed and held down, the brightness will quickly step up or down. If the rear camera has been selected, the buttons turn the LED light cluster on/off.
- **Horizontal Motor Joystick** - controls the horizontal motors. Push straight forward and both motors drive the ROV forward (proportional to the amount of forward movement of the joystick.) The maximum drive available is controlled by the Horizontal Motor Control knob setting on the control panel. If the joystick is moved forward and to the left or right then motor power is reduced in one motor so that the ROV will turn in the direction of the joystick movement.  
If the joystick is pulled back, then the motors go in reverse and the ROV goes backwards and can go left or right as it is backing up.  
If the joystick is moved directly left or right, the horizontal motors go in opposite directions which causes the ROV rotate left or right.
- **Vertical Motor Joystick** - controls the vertical motors. Push straight forward and both motors drive forward (proportional to the amount of forward movement of the joystick.) The maximum drive available is controlled by the Vertical Motor Control knob setting on the control panel. If the joystick is moved forward and to the left or right then motor power is reduced in one motor so that the ROV will continue up, but will also move sideward in the direction of the joystick movement.  
If the joystick is pulled back, then the motors go in reverse and the ROV goes down and can go left or right as it is going down.  
If the joystick is moved directly left or right, the vertical motors go in opposite directions which causes the ROV to move left or right with little change in depth.



## Control Box: (continued)

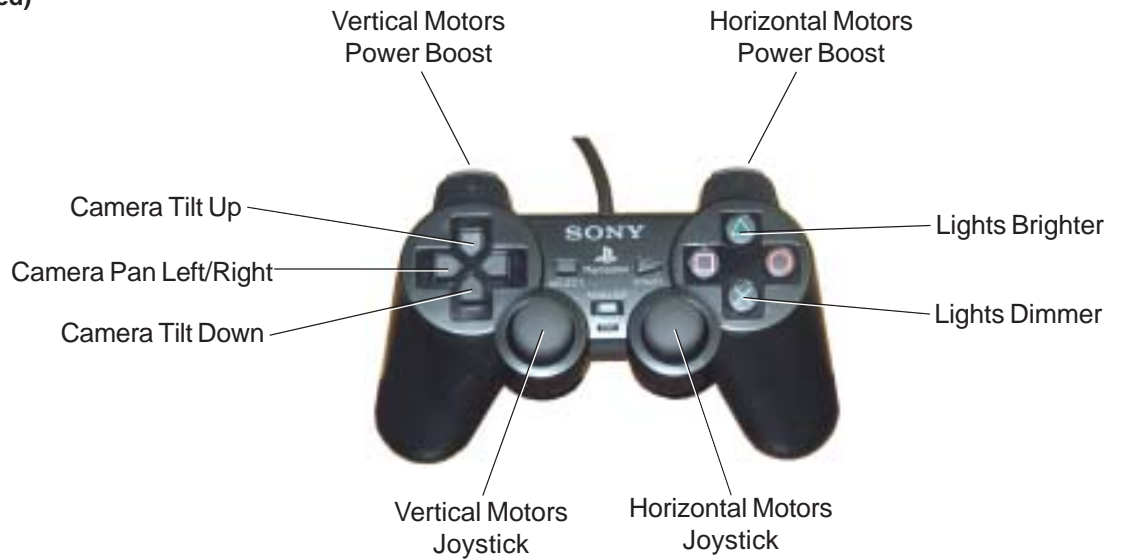

### PS2 Back View



## PS2 Controller: (continued)

An off-the-shelf PS2 controller (supplied), plugs into the control panel and controls the ROV's: lights, motors, and camera movement. Wireless PS2 controllers can also be used

- **Horizontal and Vertical Motor Low Power Buttons** - when depressed, and held depressed, reduces the power available to the motors by 50%. Very useful when the ROV is working close to an object. If the power was already reduced by the control panel knob, then these buttons reduce the power available even further.
- **Horizontal and Vertical Motor Power Boost Buttons** - when depressed, and held depressed, increases the power available to the motors by 30-40%. Very useful when encountering heavy currents, or when dragging a very long cable. When these buttons are depressed the power control panel knobs are ignored, and the power available to the motors is 30-40% higher than the full power setting.

**We are ready to cable up the system**

## Cabling the SeaLion-2

The drawing below shows the cable connections for the SeaLion-2.

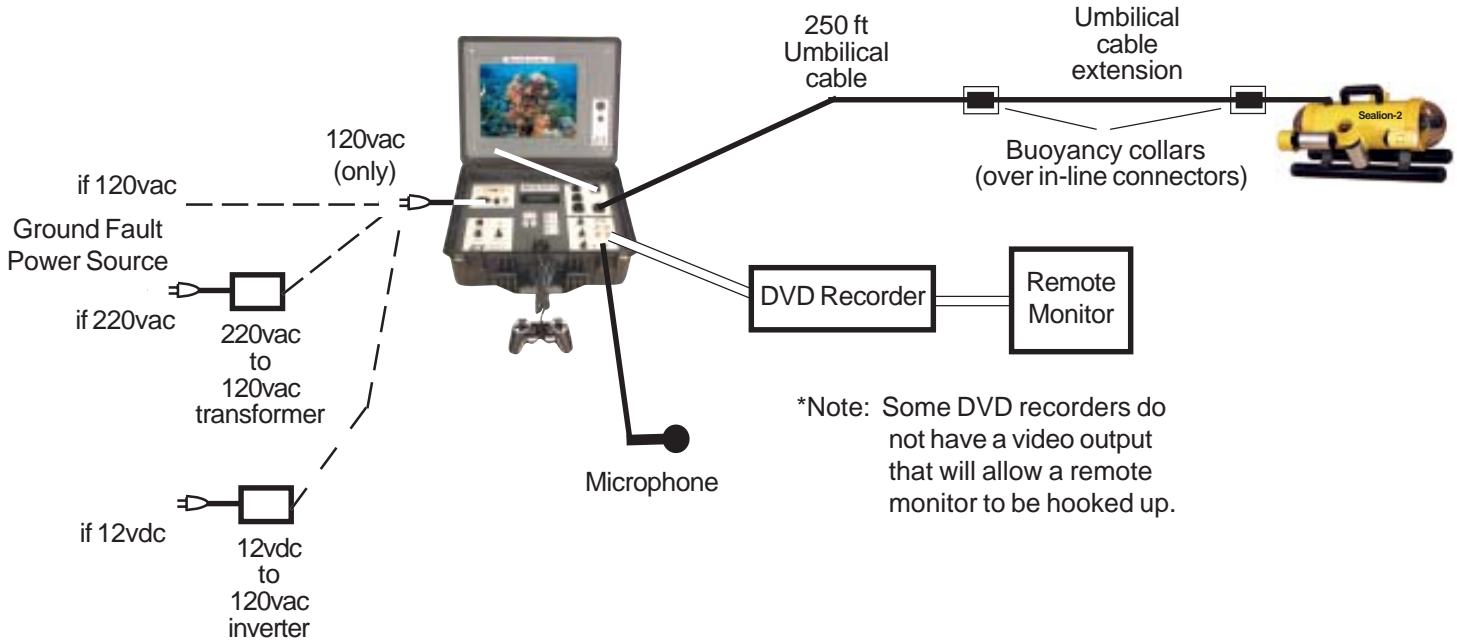

### Step 1.

After opening the control box cover, plug the cable from the cover into the Video Display connector on the control panel. Be careful the cover does not fall forward (closed) after the cables have been plugged into the control panel. The cover can be removed by removing (pull out) the two pins in the hinge.

### Step 2.

Attach the umbilical cable to the ROV and to the control box. Be careful while handling the connectors. The pins or internal wiring can be broken if twisted or bent sharply. An umbilical extension cable can be ordered if needed, the total length cannot exceed 1,500.

### Step 3.

If the video is going to be recorded using an external DVD recorder, then connect the recorder (not supplied by JWF) to the Video Out connector on the control panel. Also include a cable between the recorder and Audio Out connector on the control panel if a microphone (not supplied by JWF) is being used. The microphone has its own connector on the control panel.

### Step 4.

If a remote monitor is being used, connect the monitor's cable to the Video Out connector on the control panel. Monitor power can be plugged into control panel outlet (120 vac).

If both a recorder and a remote monitor is being used, then connect the recorder cable to the Video Out connector (use both the video and audio cables) and connect the monitor to the DVD output connectors. Monitor and recorder power can be plugged into control panel outlet (120 vac).

## Cabling the SeaLion-2 (continued)

The drawing below shows the cable connections for the SeaLion-2.

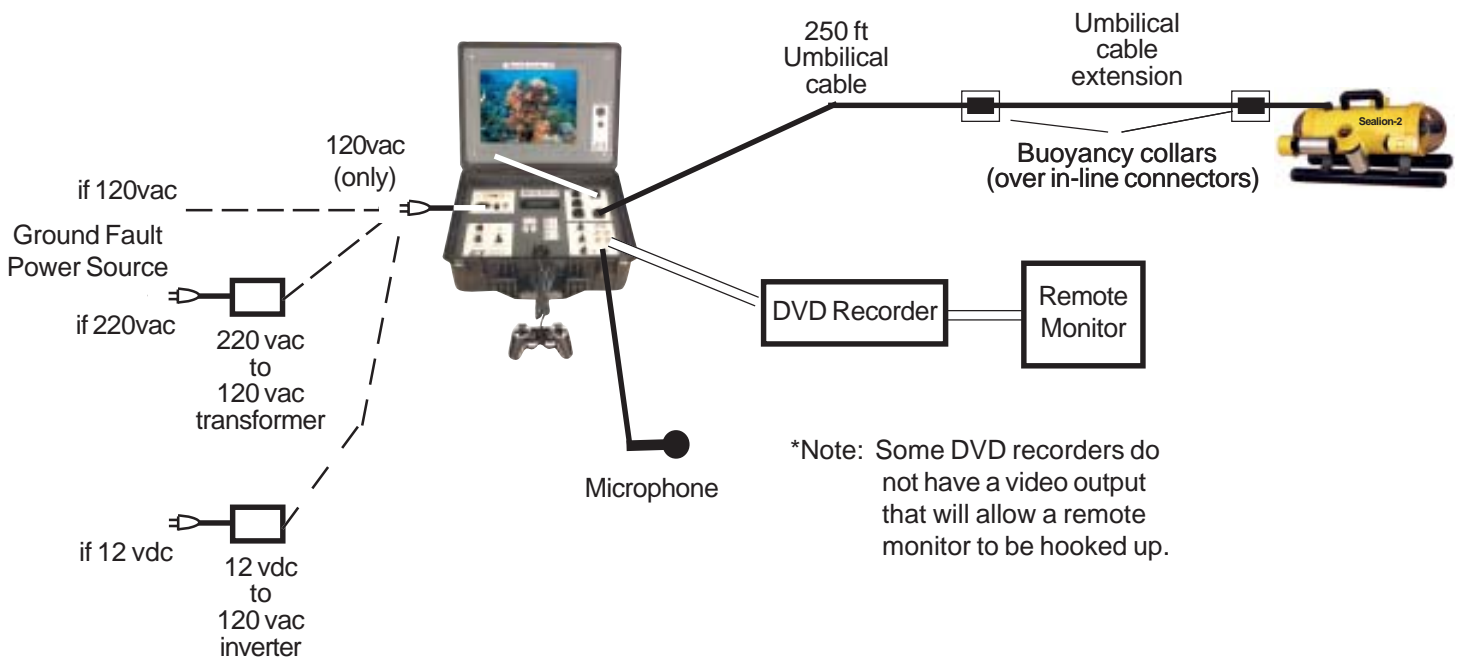

### Step 5.

Connecting power (be sure Main Power Switch on control panel is turned off) :

- Never connect any voltage other than 115 - 120 vac to the control box.
- The best source of 120 vac is a generator (1,500 watt or higher).
- If only 220 is available use a 220 to 120vac step down transformer (1,500 watt, JWF can supply).
- If only 12 vdc is available use an 12 vdc to 120 vac inverter (1,500 watt, JWF can supply).
- For safety reasons, a ground fault outlet should be used.

**We are ready to power up the system**

## Powering up the SeaLion-2

The first power up and checkout will be done out of water (do not turn on front lights or run motors for more than a second or two.)

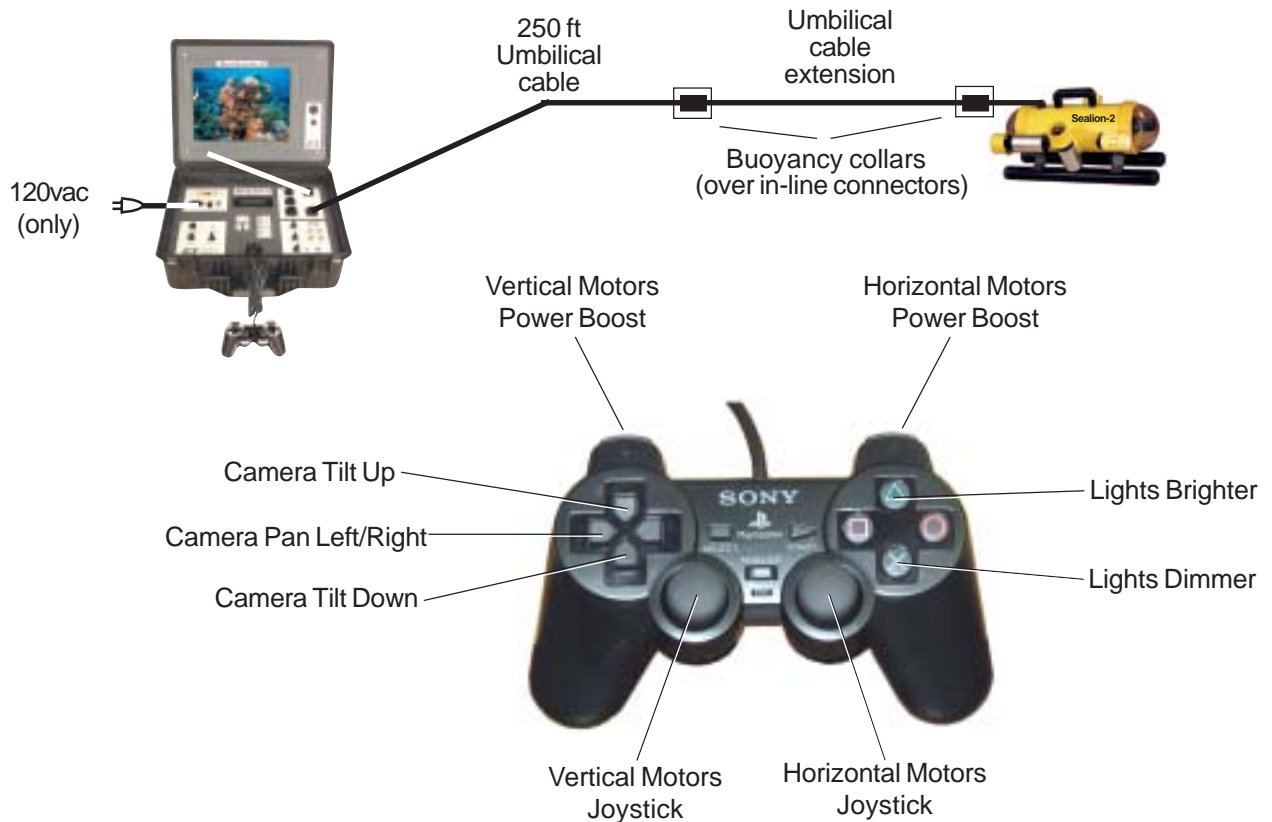

### First test run (out of water):

- 1) Turn off the Master Motor Switch on the control panel.
- 2) Rock each propeller back and fourth (1/4 turn) a few times to insure motors are free to turn (if the ROV has been in storage the seals can stick, this rocking frees the seals.)
- 3) Turn on the Power On Switch on the control panel.

- 4) The monitor will be blank and the control panel readout will display

**JW Fishers  
Sealion-2**

- 5) After 5-10sec delay (internal self check), the monitor will display the video from the selected camera. The System is ready to go.

Note: if the video does not display, check the Monitor Source switch on the control box cover. It should have ROV selected as the source.

## First test run (out of water): continued

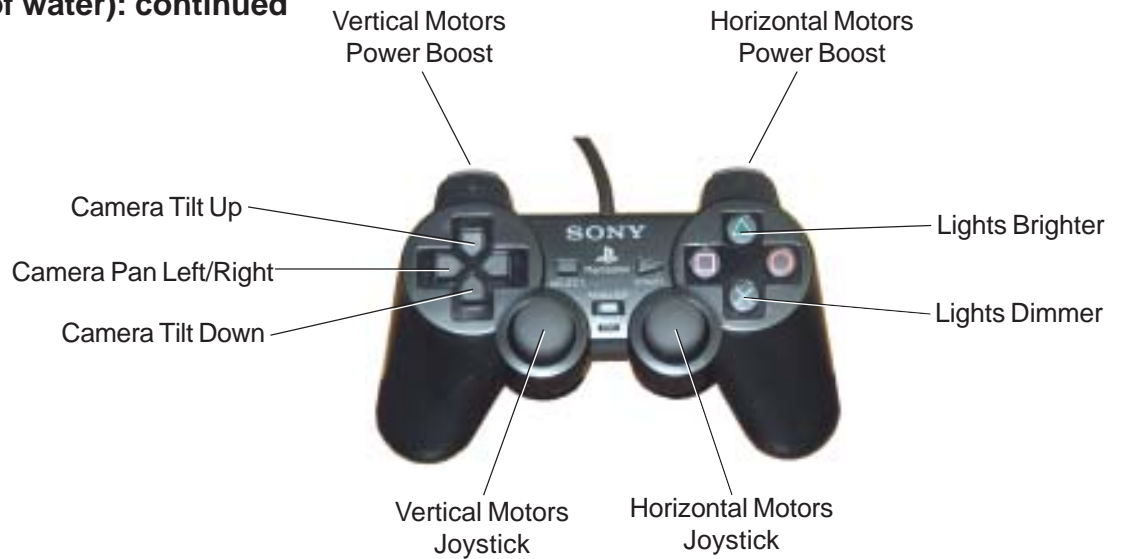

- 6) Select the rear camera (camera switch on control panel).
- 7) Using the pan and tilt buttons on the PS2 controller (left set of buttons ), move the camera left/ right and up/down. Note that the control panel readout displays the position of the camera.
- 8) Turn on/off the LED light ring by pressing the on and off buttons on the PS2 controller (the right set of buttons).
- 9) Select the front camera (switch on control panel). Using the pan and tilt buttons on the PS2 controller (left set of buttons ), move the camera left/right and up/down. Note that the control panel readout displays the position of the camera.
- 10) Select the front camera (camera switch on control panel).
- 11) Using the pan and tilt buttons on the PS2 controller (left set of buttons ), move the camera left/ right and up/down. Note that the control panel readout displays the position of the camera.

### **CAREFUL WITH THE NEXT STEP**

(heat can damage the light housings if lights are left on for more than 5-10 seconds out of water)

- 12) Momentarily turn the front lights by pressing the on and off buttons on the PS2 controller (the right set of buttons). Each time the top button is depressed the lights get brighter. Each time the lower button is depressed the lights get dimmer. If the button is depressed and held down, the lights will quickly step brighter or dimmer.

## First test run (out of water): continued

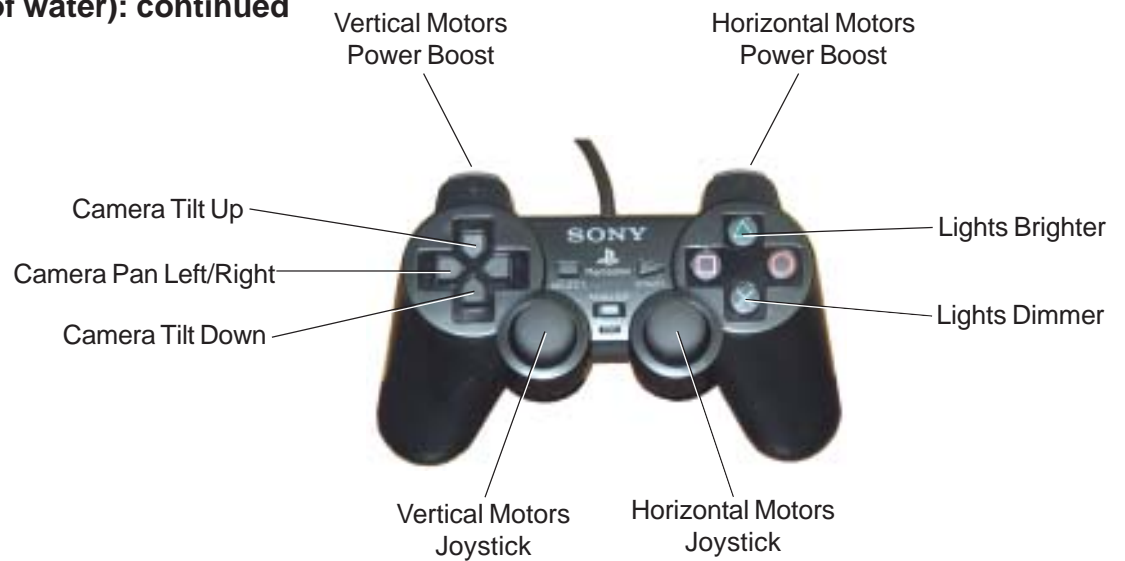

13) On the control panel, set the Horizontal and Vertical motor power controls to half power (5).

14) Set the Vertical Motor Trim control to midway (0).

### **KEEP HANDS/FINGERS AWAY FROM MOTORS**

15) Turn on the Master Motor Switch (allows power to the motor).

### **CAREFUL WITH THE NEXT STEP**

(motor seals can be damaged if the motors are left on for more than 5-10 seconds out of water)

16) Move the horizontal and vertical joysticks (for a few seconds) to insure the motors are running.

17) Turn off the Master Motor Switch.

### **TIME TO GET THE ROV WET**

## Water Operation:

### Balancing the SeaLion-2

The SeaLion-2 was designed for ease of operation, however, prior to its use it must be balanced and its buoyancy adjusted for it to perform correctly. Proper balance is very important in order to insure proper flight characteristics. If the SeaLion-2 is nose heavy, it will dive as it goes forward; and if it has a heavy side, it will exhibit unstable side motion characteristics. If its buoyancy is too positive it will be difficult to drive underwater without it coming to the surface. If its balance is correct, it will float level in the water. If its buoyancy is correct, the water line will be just above the top of the body..

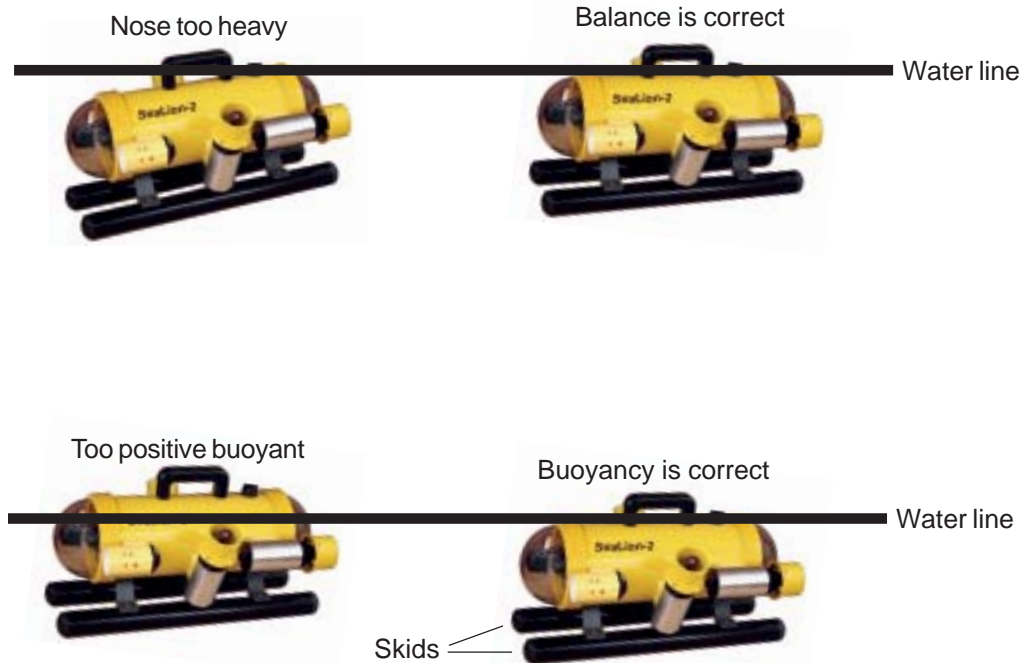

The SeaLion-2 comes equipped with ballast lead installed in the skids. Additional small "fine balancing" weights are also included in the SeaLion's shipping box. In order to properly "fine tune" the balance and buoyancy of the SeaLion, you must first place it in the water with the cable attached and the buoyancy collar over the in-line connector. Be sure to be in the same kind of water (fresh/salt) as where you will be operating it. The SeaLion-2 should submerge to an almost neutrally buoyant state, evenly balanced from side to side, and front to rear. When properly balanced, the SeaLion-2 should be slightly positive buoyant.

### Skid

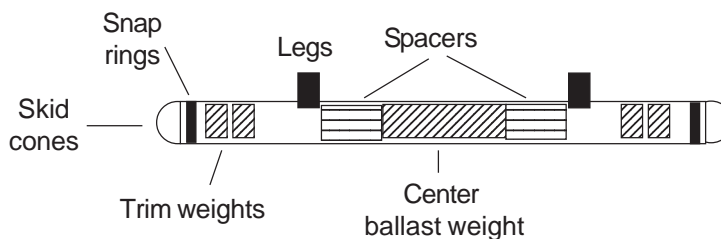

## Water Operation (continued):

### Balancing the SeaLion (continued)

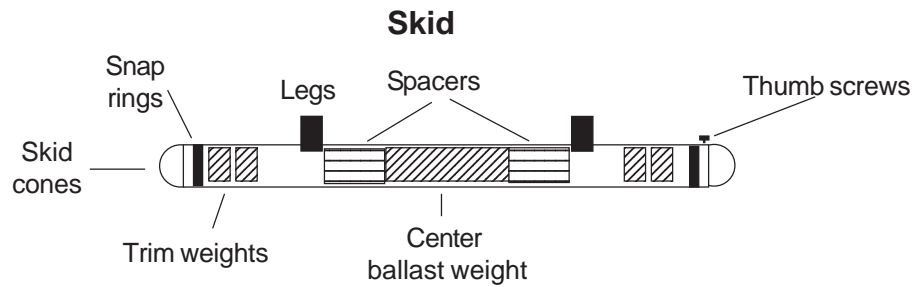

To change the weight for "fine balancing" the SeaLion. Remove the small thumb screw holding the skid cone on, and remove the cone. Inside the skid is a plastic snap ring that holds the weights that are already in place. If it is necessary to reduce the weight, pull out the plastic snap ring and remove some of the internal weights. If additional weight is necessary, slide one of the fine trim weights into each end of each skid. Be sure to install the cones back into the skids to observe the total effect of the added weight. Any type of weight may be used to balance the SeaLion.

When the SeaLion is properly balanced, a slight downward push in the center area of the ROV sends the unit down and it very slowly comes back to the surface. A few extra minutes performing this procedure will insure impressive trouble-free flying.

It is recommended that before going into open water with the ROV, that several hours be spent at a local pool or at a body of water that has good visibility, so that you can watch the ROV while you work the joysticks.

If you have problems or questions at any time please fax, call, or email the factory

### Launching and retrieving the SeaLion-2

The SeaLion is a rugged piece of equipment, however, it should be treated with care. Use the handle, not the motors or lights, to lift or lower the SeaLion. Never try to lift or lower the unit by holding it by the umbilical cord, this may result in damage to the signal or power cable. For safety reasons, insure that all electrical connections are not exposed to water and that the control box is plugged into a ground fault outlet.



# SeaLion-2 Control Box Block Diagram

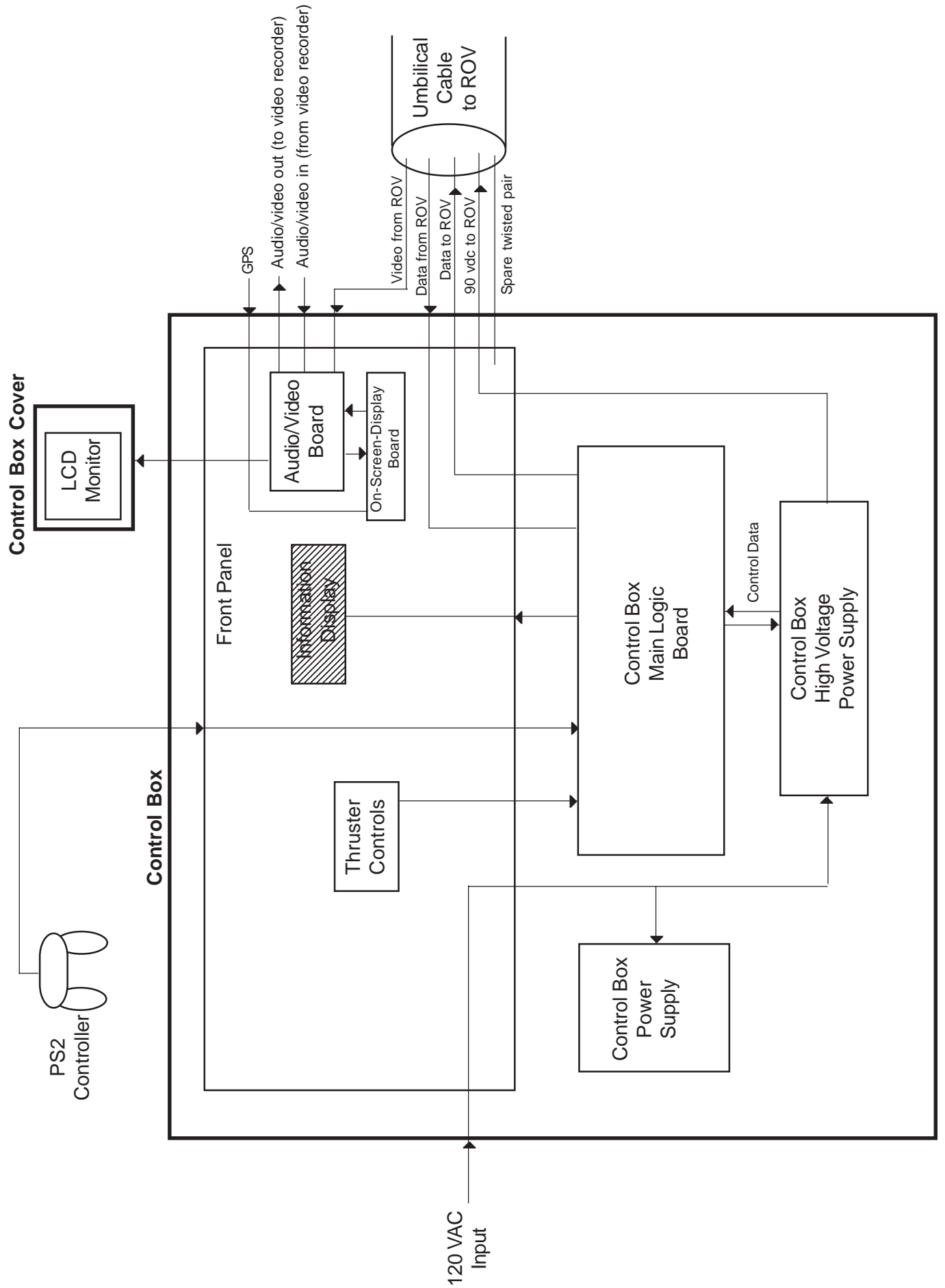

# SeaLion-2 ROV Block Diagram

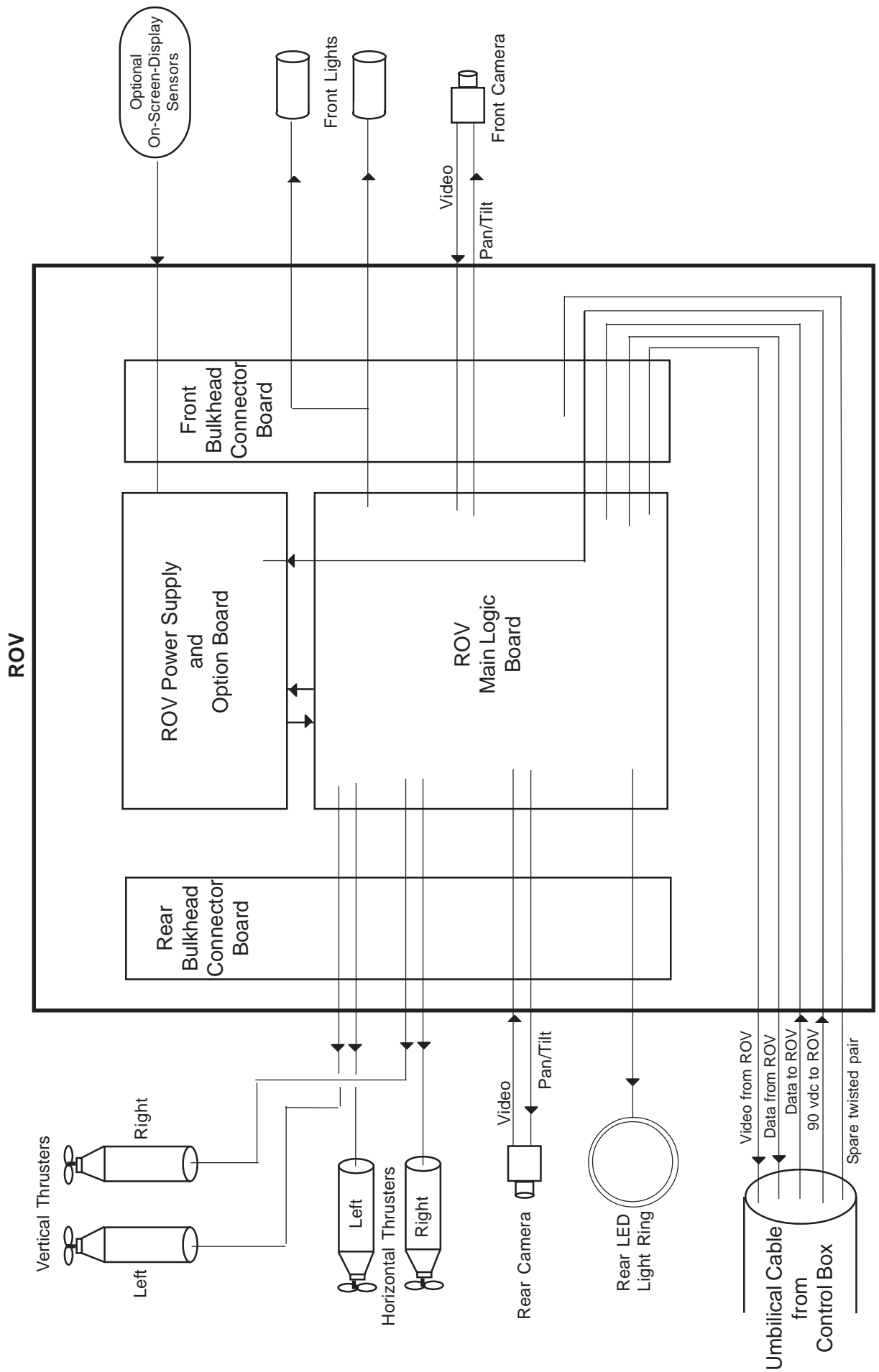

## MAINTENANCE

Your Sealion was designed to be maintenance free. The ROV, cable, and control box are constructed of corrosive resistant materials. After operating in salt water the ROV should be rinsed off in fresh water. If the ROV has not been used for awhile; move the props back and forth to insure the seals are not sticking (be sure power is turned off and the unit is unplugged). The equipment should be stored in a cool, dry place. Do not allow equipment to sit in the hot sun.

## LIMITED WARRANTY

Your SeaLion underwent constant inspection during assembly to insure many years of trouble free performance. The system is warranted for TWO FULL YEARS from the date of purchase. During this period the SeaLion will be repaired free of charge should a failure occur due to materials or workmanship under normal use.

The warranty does not cover lost equipment, broken cables or connectors, or damage due to dropping or general misuse. The warranty covers JW Fishers equipment only. JW Fishers will not be liable outside of the remedies stated above.

Should service be required, write or phone us explaining the nature of the problem. Most problems can be isolated over the phone and the correct replacement parts sent to you. The system is field repairable at the board level. Do not attempt to troubleshoot or repair the board. We will swap boards; we will not send out schematics or parts for the boards.

### RETURNING EQUIPMENT FOR REPAIR

If your Sealion should need service, please call, fax, write, or e-mail: [info@jwfishers.com](mailto:info@jwfishers.com), phone (508) 822-7330, or fax (508) 880-8949 the factory for instructions. We do not require authorization for the return of equipment. If you have a problem with your sonar and would like to have it checked out and repaired at the factory, simply pack it well and return it with a brief note describing the problem. Customer pays shipping costs.

Be sure to include your return address and telephone number on the note. When returning equipment from outside of the US, to avoid Custom problems when arriving in the USA, contact the factory for specific instructions regarding shipping.

Contact the factory for instructions should you encounter any problems.



**JW FISHERS MFG INC**  
1953 COUNTY ST.  
E. TAUNTON, MA 02718 USA

(508) 822-7330; (800) 822-4744; FAX (508) 880-8949  
Email: [jwfishers@aol.com](mailto:jwfishers@aol.com) WEB: [www.jwfishers.com](http://www.jwfishers.com)

## **SeaLion-2 Spare Parts**

The SeaLion shipped with an assortment of O-rings and hardware. Additional spare parts, which are listed below, are available by calling or writing the factory. There is a Basic Spare Parts and an Enhanced Spare Parts kit available.

### **Basic Spare Parts Kit:**

1. (1) Dome
2. (2) Dome O-rings
3. (6) Dome screws 6-32 x 3/4" AH
4. (2) Motor housing O-rings
5. (1) Complete Motor, Cone, Seal, Kort nozzle, Prop.
6. (4) Motor housing screws 4-40 x 1/4" PH
7. (2) Lamps & Sealant
8. (1) Lamp housing with cap
9. (1) Light housing holder
10. Light housing screws; (2) 10-32 x 3/4" AH and (2) 10-32 x 3/4" FH
11. (1) End leg (drilled for On-Screen Display)
12. (2) End leg screws 10-32 x 1/2" AH
13. (4) #10 Flat washers
14. (4) #10 Lock washers

### **Enhanced Spare Parts Kit:**

ALL THE ITEMS IN THE BASIC KIT PLUS:

15. A second complete Motor, Cone, Seal, Kort nozzle, Prop.
16. (2) More lamps for a total of four.
17. (2) Rotary seals
18. (8) 1/16" x 1/2" Spring pins

# External DVD Recorder Option

## Connection to the Optional Sony VRD-MC10 DVD Recorder

### SeaLion-2 Control Box



Top Panel

Side Panel



Sony DVD Recorder

Video Area

To Record to DVD

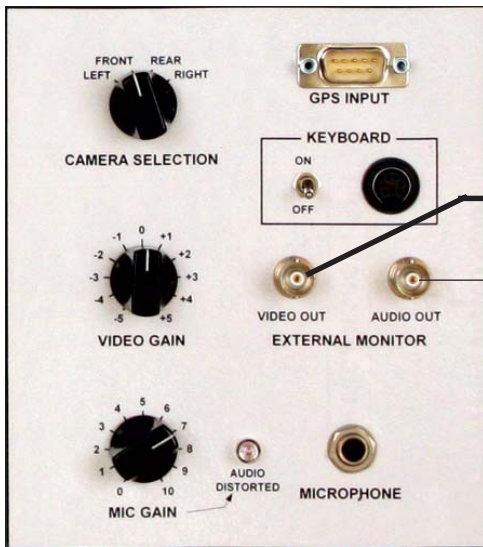

Video Out

Audio Out

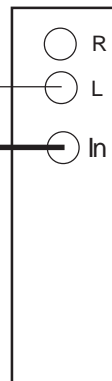

Audio in

L

Video in

In

Side Panel of DVD Recorder

### NOTE:

- 1) Audio Record and Playback is from Left (L) Channel Only
- 2) If you are not using a microphone, there is no need to connect the audio cable.

See Sony manual for operation of the DVD Recorder

## Built in DVR Option

### Built in DVR:

The Digital Video Recorder (DVR) option records 12 hours of high quality video on a standard 16GB SD card. Any capacity SDHC card up to 32GB may be used. The following controls and switches are located on the DVR.



Control Panel layout with built-in DVR

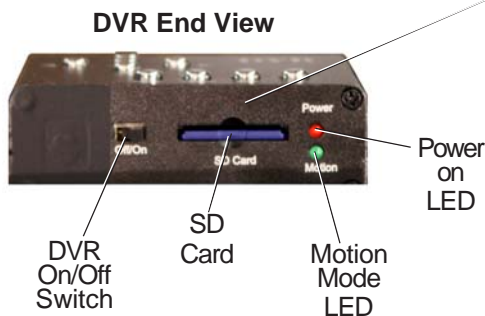

DVR End View

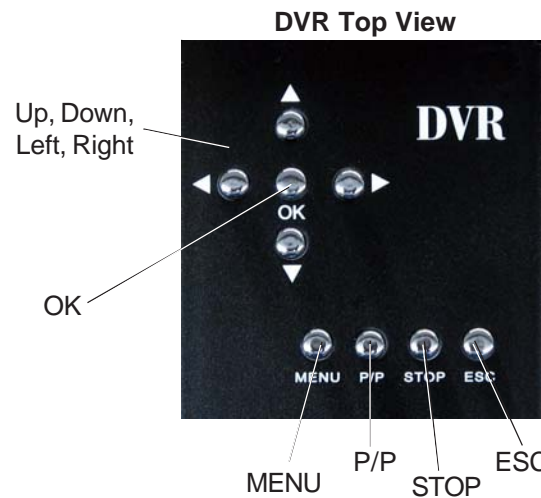

DVR Top View

### Top Panel:

- **MENU** - Gives access to the DVR's software setup screens.
- **ARROWS** - scrolls menus, also Volume Up, Volume Down, Reverse and Fast Forward.
- **OK** - Used to choose the selected software setting. **Also used to Start Recording.**
- **P/P** - Use to Play, Pause or Delete prerecorded files.
- **STOP** - Used to Stop Recording or Stop Playback.
- **ESC** - Used to Escape menus.

### End Panel:

- **DVR On/Off Switch** - Turns the DVR power on/off. Leave in the On position.
- **Power on LED** - Flashes when DVR power switch is on.
- **SD Card** - Removable memory card for storing files.
- **Motion Mode LED** - Illuminates when recorder is in motion triggering record mode.

## Option

### DVR (continued):

The DVR (Digital Video Recorder) uses an SD memory card to store the video recordings. Any capacity card up to 32GB can be used. Recording time on a 16GB card is approximately 12 hours when using the highest quality frame rate, 30 fps (frames per second). Using a lower frame rate will allow longer recording times but the recorded motion will not be as smooth, however, the picture quality of still images will be the same. The SD card used should not contain other files (example: photos taken with a digital camera).

Always turn OFF the Main Power switch before installing or removing the SD card.

To load the SD card into the DVR, insert it into the SD Card slot with the notched corner to the left (SD card will be UPSIDE-DOWN with its label facing DOWN!). Push the card in until it is flush with the panel and 'clicks' into place. You will feel spring tension before the card is fully engaged. Before beginning to record on a new SD card, use the FORMAT function to format the card. Formatting the SD card will erase all files stored on the card!

To remove the card, push it in slightly against the spring pressure until it 'clicks' and releases. Pull it out the rest of the way. The video files recorded onto the SD card can be transferred to a PC and viewed. The file format used is Mpeg-4 Video ASF.



**Flip over  
to insert**

## Option

### DVR (continued):

#### DVR Initial Setup

Turn on the Sealion-2 Main Power switch, after a few seconds, the red Power LED on the DVR will light (blink constantly). The DVR power switch is normally left on.

The main screen for the DVR will show on the monitor.

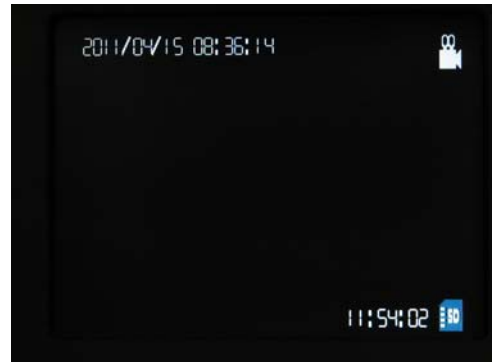

**MAIN SCREEN FOR DVR  
(DISPLAYED ON MONITOR)**

Press the MENU button on the DVR panel to access the DVR's SETUP menu. Use the UP and DOWN arrow buttons to scroll to the following items:

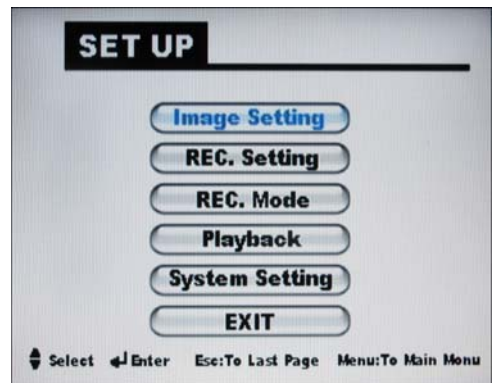

**SETUP MENU  
(DISPLAYED ON MONITOR)**

#### **Image Setting:**

In the Setup menu, scroll down to highlight Image Setting. Press OK to enter the Image Setting menu.

Scroll to highlight Quality.

Press OK.

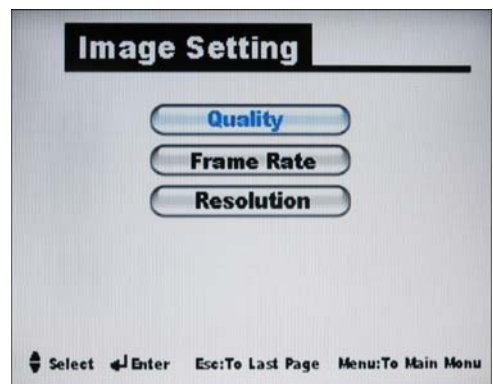

**QUALITY IMAGE SELECTED**



## Option

DVR (continued):

### Image Setting: (continued)

The Quality choices are High (H) (recommended), Medium (M) and Low (L). Scroll to highlight H.

Press OK to store the choice and return to the Image Setting menu.

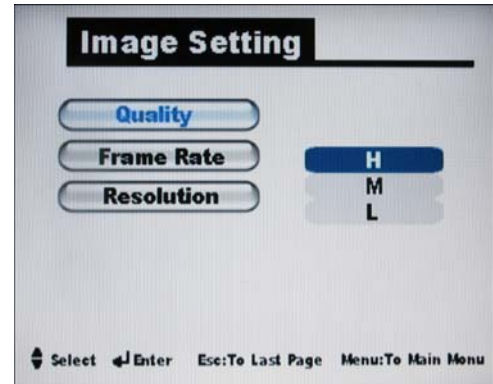

QUALITY IMAGE SETTING

Scroll to highlight Frame Rate.

Press OK.

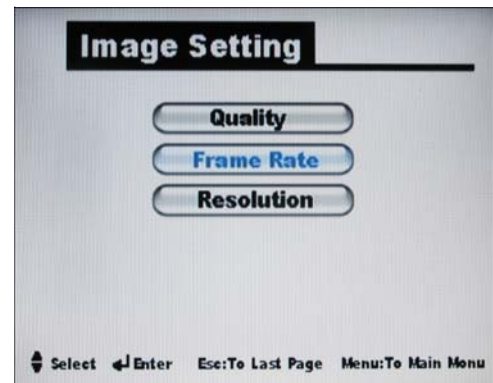

FRAME RATE SELECTED

The Frame Rate choices are 30fps (video frames per second), 15fps and 5fps. 30fps provides the smoothest motion video. Scroll to highlight 30fps.

Press OK to store the choice and return to the Image Setting menu.

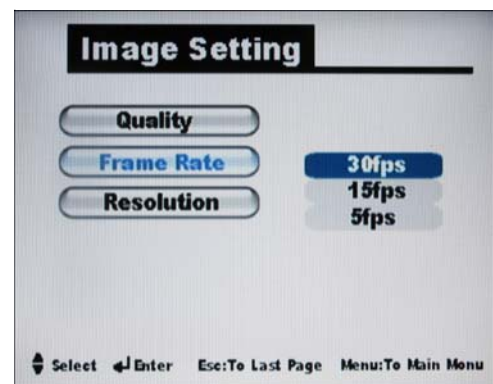

FRAME RATE SETTING

## Option

DVR (continued):

### Image Setting: (continued)

Scroll to highlight Resolution.

Press OK.

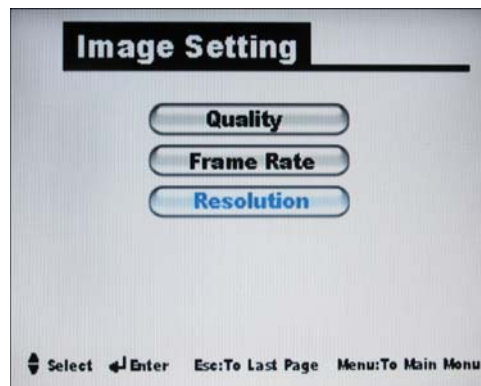

**RESOLUTION SELECTED**

Scroll to select VGA to best match the resolution of the video camera.

Press OK to store the choice and return to the Image Setting menu.

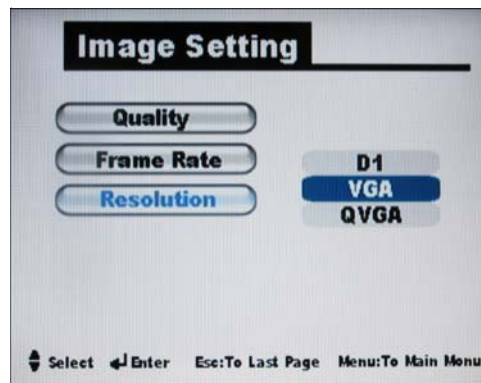

**RESOLUTION SETTING**

Press ESC to return to the SETUP menu.

## Option

DVR (continued):

### REC. Setting:

In the Setup menu, scroll down to highlight REC. Setting.

Press OK to enter the REC. Setting menu.

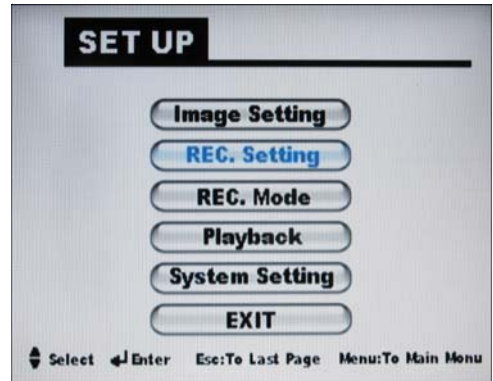

**REC. SETTING SELECTED**

Scroll to highlight Overwrite.

Press OK.

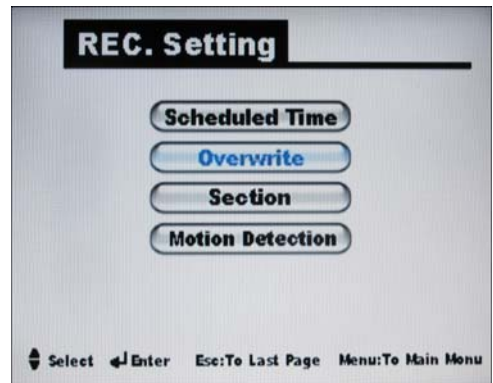

**OVERWRITE SELECTION**

The Overwrite choices are Yes and No. Selecting Yes will allow the DVR to automatically overwrite existing files once the SD card is full. Selecting No (recommended) will prevent files from being overwritten. When the SD card is full, recording will stop. Scroll to highlight No.

Press OK to store the choice.

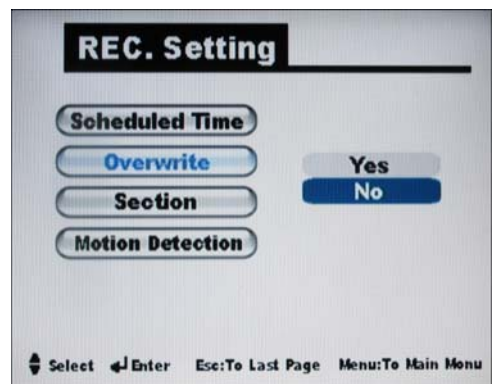

**OVERWRITE SELECTED**

## Option

DVR (continued):

### REC. Setting: (continued)

Return to the REC. Setting menu.

Scroll to highlight Section.

Press OK.

The DVR automatically starts a new recording file after the selected time has elapsed. This keeps each file to a manageable size. The choices are 15 min, 30 min or 1 hr. Scroll to highlight the desired choice.

Press OK to store the choice and return to the REC. Setting menu.

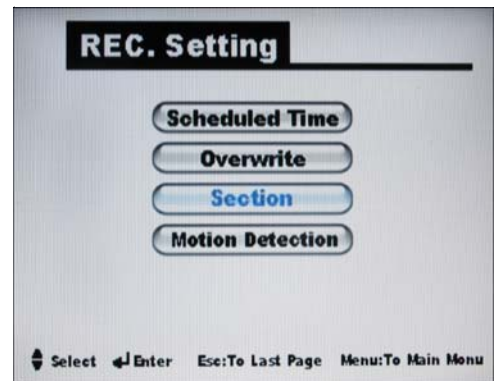

### SECTION SELECTION

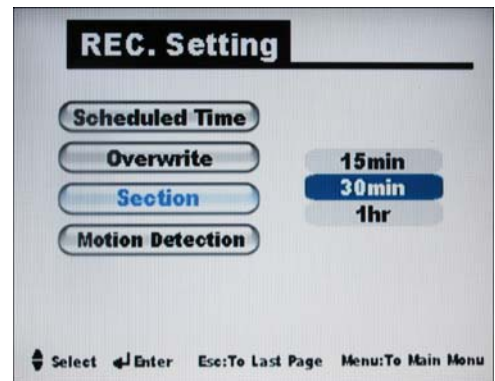

### SECTION LENGTH SELECTED

The Scheduled Time feature allows the user to set a predetermined start and stop recording time and date.

The Motion Detection feature initiates recording when motion is detected by the camera.

Both functions are generally not used in this application. See the DVR manual for details if you wish to use these functions.

Press ESC to return to the main SETUP menu.

## Option

DVR (continued):

### REC. Setting: (continued)

In the Setup menu, scroll down to highlight REC. Mode.

Press OK to enter the REC. Mode menu.

The REC. Mode selection determines how a new recording is initiated. Scroll to select Manual.

Press OK to store the choice and return to the main SETUP menu.



REC. MODE SELECTION

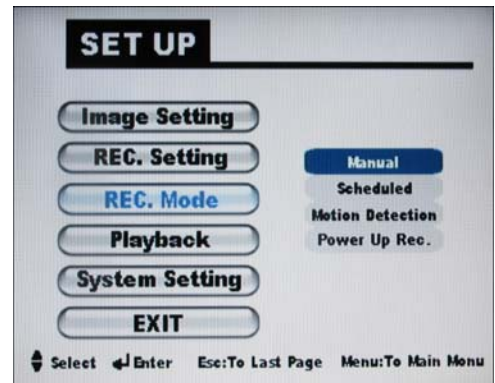

REC. MODE SELECTED

## Option

DVR (continued):

### System Setting:

In the Setup menu, scroll down to highlight System Setting.

Press OK to enter the System Setting menu.



SYSTEM SETTING SELECTION

Language: In the System Setting menu, scroll to select Language.

Press OK to enter the Language menu.

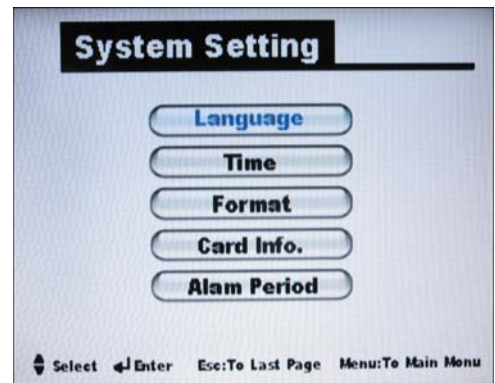

LANGUAGE SETTING SELECTION

The language choices are limited to English, Chinese and Simple Chinese. Scroll to highlight the desired language.

Press OK to store the choice and return to the System Setting menu.

**WARNING:** Once selected and stored, all menus will only be displayed in the language that was selected. It may be very difficult to correct.



LANGUAGE SELECTED

## Option

DVR (continued):

### System Setting: (continued)

Current Time: In the System Setting menu, scroll to highlight Time.

Press OK to enter the Time menu.

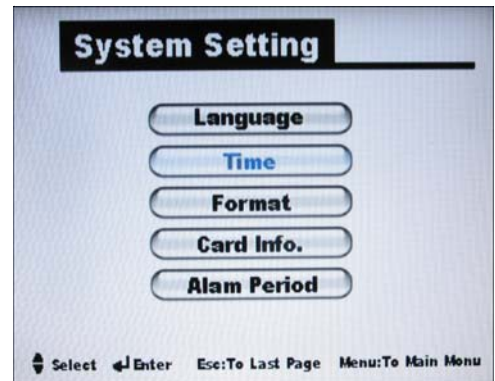

### TIME SELECTION

The files are tagged with the date and time of the recording so it is important that the Date and Time are set correctly.

Scroll right and left to choose to modify the current year, month, day, hour or minutes. Scroll up and down to modify each selection.

Press OK to save the current date and time and return to the System Setting menu.



### TIME SELECTED

## Option

DVR (continued):

### System Setting: (continued)

Format the SD card: In the System Setting menu, scroll to select Format.

Press OK to enter the Format menu.

**Warning: Formatting the SD card will erase it's entire contents. All files will be lost. Format only when using a new card or when you wish to remove all files!**



SD FORMAT SELECTION

Scroll to select Yes to format the SD card. Formatting will begin and may take several minutes. Once Formatting is complete, the DVR will return to the System Settings menu automatically.

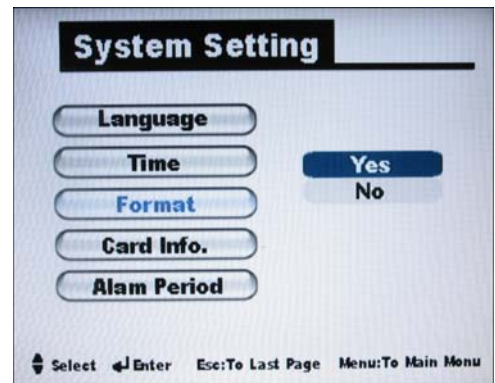

SD FORMAT SELECTED



## Option

DVR (continued):

### System Setting: (continued)

Card Info: In the System Setting menu, scroll to highlight Card Info.

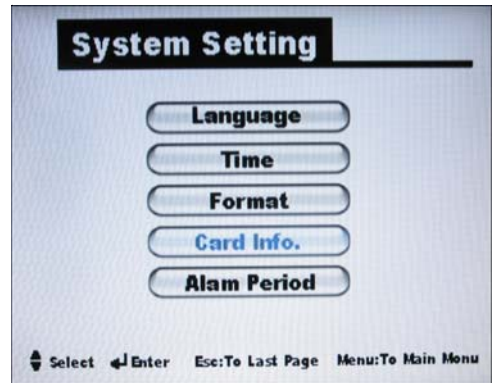

**CARD INFO. SELECTION**

Press OK to display the total size, percentage of size used and percentage of size available for the SD card.



**CARD INFO. SELECTED**

Press OK to return to the System Setting menu.

Alarm Period: not used, should be set to Always Off.

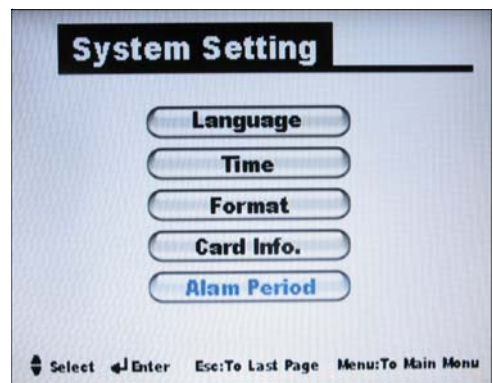

**ALARM PERIOD SELECTION**

Scroll to select Exit. Press OK to return to the main DVR screen.

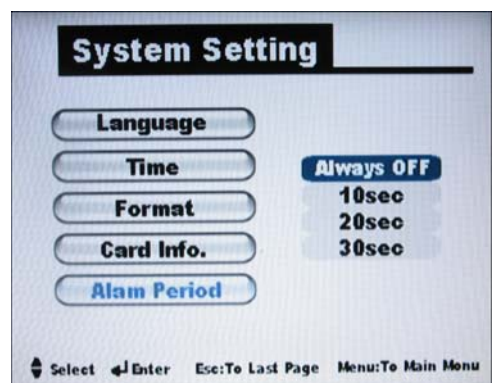

**ALARM PERIOD SELECTED**

## Option

### DVR (continued):

#### To Record Video on the DVR

Be sure an SD memory card is installed with sufficient blank space available.

1) Turn on the Sealion-2 Main Power switch, after a few seconds, the red Power LED on the DVR will light (blink constantly), The main screen for the DVR will briefly show on the monitor

2) After a brief delay, the image from the ROV camera will be displayed on the monitor.

3) Before the video signal is sent to the monitor(s) it goes through a video amplifier. The gain is adjustable. Set the control midway to 0. (Refer to page 11 for more details)

4) If the DVR is currently in the Set Up menu, scroll down to highlight Exit and press OK. This will return it to the main DVR screen. The main DVR screen displays the current time at the top of the screen and picture of a video camera in the upper right corner. The picture from the camera is also visible.

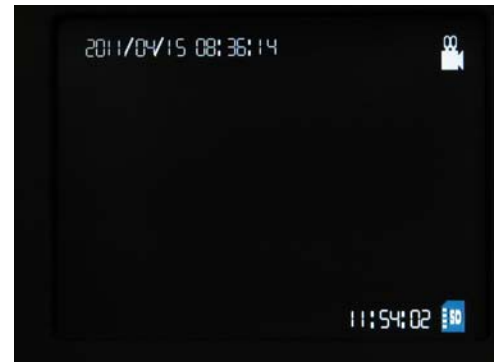

**MAIN DVR SCREEN**

5) Press the OK button on the DVR panel one time to begin recording. The red dot should flash next to the word 'REC' in the lower left corner of the screen.

6) The elapsed time of the recording is displayed in the upper right corner of the screen. The current time is displayed in the lower right corner of the screen.

7) Press the STOP button on the DVR panel to end the recording. You will be returned to the main DVR screen.



**MAIN SCREEN RECORDING**

8) The recorder automatically creates and names a new file for each recording. When the elapsed time of the recording reaches the time selected in the menu item Rec. Setting / Section, a new file will automatically begin. The files are named simply with a sequential number. The date and time of the recording are embedded in the file. Caution: If the file name is changed (using a PC), the file will no longer be recognized by the DVR.

## Option

### DVR (continued):

#### To Play Back Recorded Files on the DVR:

Be sure an SD memory card is installed (containing previously recorded files from this DVR only).

- 1) Turn on the Main Power switch. The main DVR screen will be displayed.
- 2) Press the MENU button on the DVR front panel.
- 3) Scroll down to highlight Playback.
- 4) Press OK.



**Playback Selection**

- 5) The monitor will display a list of files that were recorded. Use the Up and Down buttons to navigate to the recording you wish to view. The selection will highlight in red. If there are more than 8 files, use the left and right arrow buttons to scroll to additional pages of files.

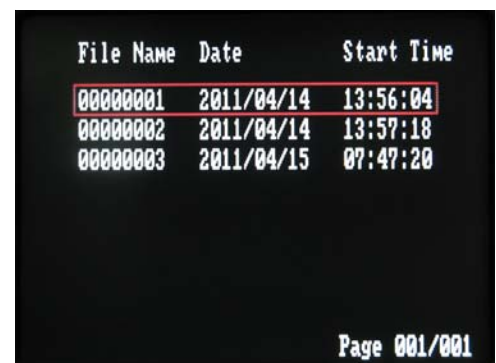

**Playback Files Selection**

- 6) Press the OK button to select the highlighted file.

- 7) Press the P/P (Playback and Pause) button on the DVR panel to begin playback. The elapsed time and total time are displayed at the top of the screen. The date and time that the recording was made is displayed at the bottom of the screen. Also at the bottom of the screen is the file number and the total number of files on the SD card.



**Playback Files Selected**

- 8) The left and right arrow buttons can be used to Fast Forward and Reverse through the file. Repeatedly pressing the left or right arrow button will change the speed, which is displayed in the upper left corner of the screen. Pressing the P/P button once will return the playback to the normal speed. Pressing the P/P button during normal speed playback toggles between Play and Pause.

- 9) The Up and Down arrows control the audio volume and should be left at max. The volume is controlled by the Volume knob on the SeaLion-2 Monitor panel.

- 10) At any time during playback, pressing the STOP button ends playback. Pressing the ESC button once will return to the list of playback files.

## Option

### DVR (continued):

#### To Delete Recorded Files on the DVR:

- 1) Turn on the Main Power switch.
- 2) Press the Menu button on the DVR panel.
- 3) Scroll to highlight Playback. Press OK to display the list of recorded files.
- 4) Scroll to highlight the file you wish to delete. Press the P/P button once
- 5) The DVR will display the Delete screen. Scroll to highlight Yes. Press OK to delete the file.
- 6) The DVR will return to display the list of recorded files. If you wish to delete more files, repeat steps 4 and 5.
- 7) Press ESC to return to the SET UP menu.
- 8) Scroll to Exit and press OK to return to the main DVR screen.

Also, all files can be deleted at once by using the Format function in the SET UP / System Setting menu.